



Think Automation and beyond...

# Operator Interface HG4G/3G/2G



## Bright and true-to-life color displays



HG4G

12.1  
inch



HG3G

10.4  
inch



HG3G

8.4  
inch



HG2G

5.7  
inch

(High Performance)



HG2G

5.7  
inch

(Basic)

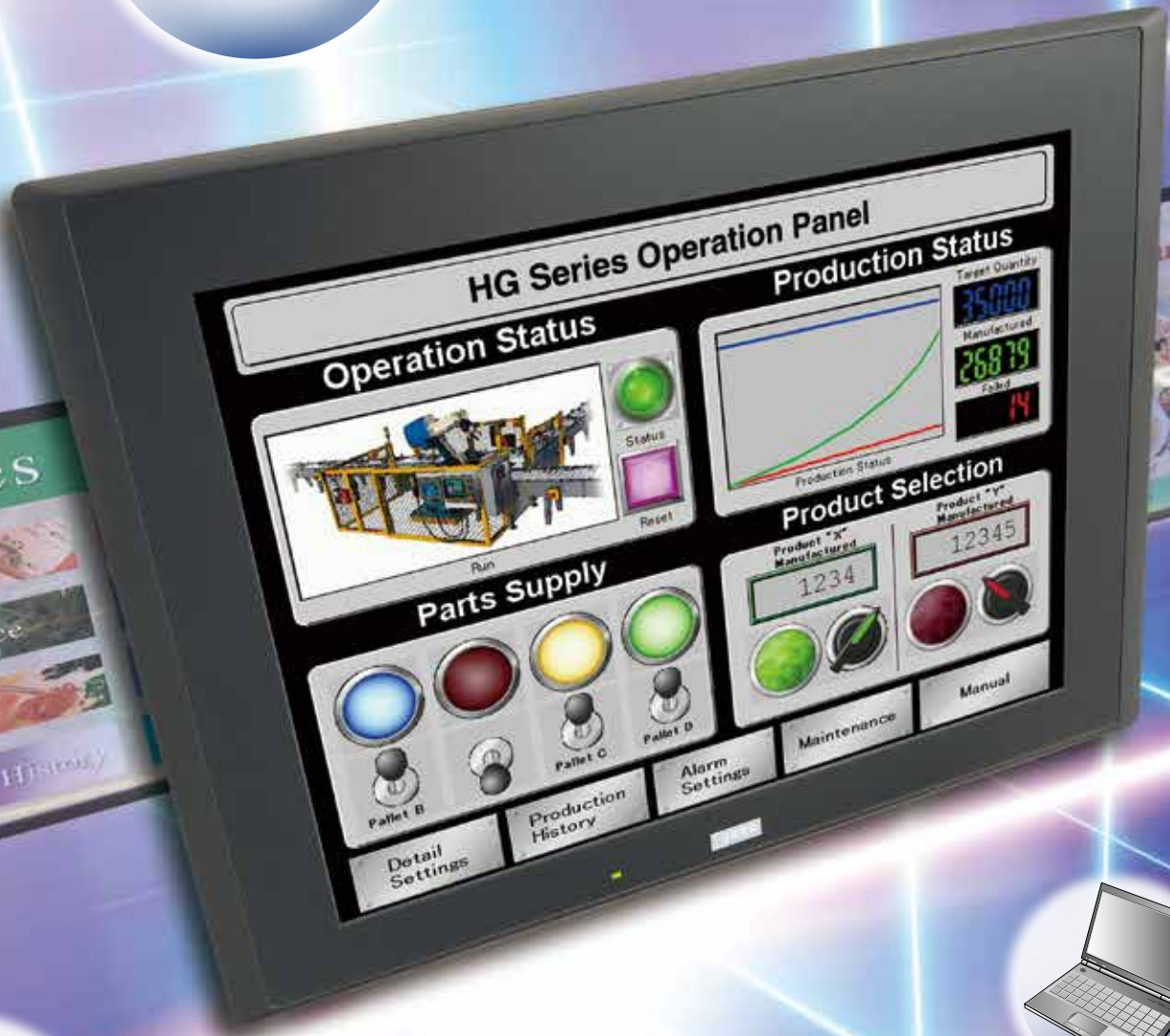

**HG4G**  
12.1 inch

Vertical  
OK



# Connect & Communicate

## “Human Machine Interface (HMI) Solutions”

IEC principle for human-machine interfaces: Fast, easy, and simple. The sharp and vivid display with high luminance connects to PLCs, micro computer boards, temperature controllers and cameras, ensuring excellent connectivity and communication in a wide range of industries. Our new range of operator interfaces provide the optimum environment for your application.



**HG3G**  
10.4 inch

Vertical  
OK

**HG3G**  
8.4 inch

Vertical  
OK

**HG2G**  
5.7 inch

Vertical  
OK

# Designed to perform

**LED**  
Backlight

True-to-life color. Brightest in its class.



HG4G  
(12.1 inch)  
**550** cd/m<sup>2</sup>

HG3G  
(10.4 inch)  
**700** cd/m<sup>2</sup>  
(8.4 inch)  
**600** cd/m<sup>2</sup>

HG2G  
(5.7 inch)  
(High Performance)  
**800** cd/m<sup>2</sup>

HG2G  
(5.7 inch)  
(Basic / Color)  
**500** cd/m<sup>2</sup>  
(Basic / Monochrome)  
**1100** cd/m<sup>2</sup>

A bright LED backlight provides a vivid display in well-lit surroundings. The brightness of the backlight can be adjusted.

**48-level**  
Brightness Adjustment  
LED backlight dimming control

The brightness of the backlight can be adjusted according to surrounding conditions (day/night).



**Graphics** More than 7,000 graphic images

1,000 graphic images have been added. Realistic images of switches, pilot lights, and other parts allow you to easily create your own custom screens.



Application Example

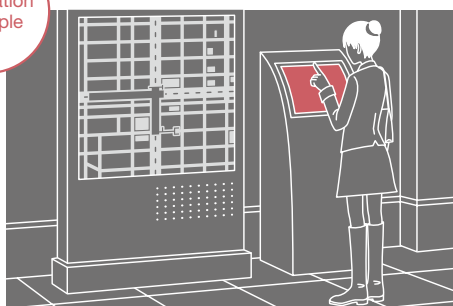



# Control

## Simple I/O Control

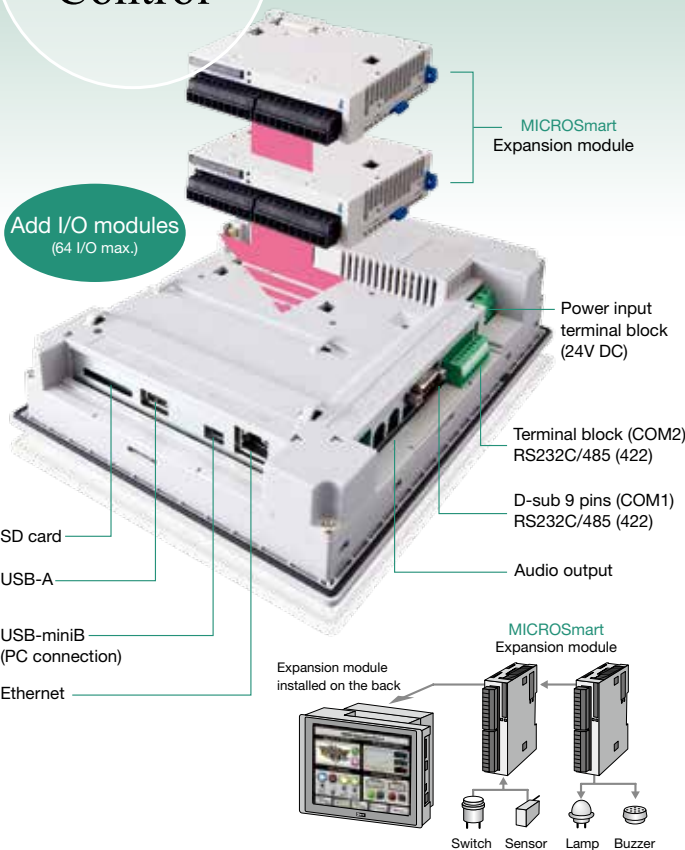

## Audio Output Sound file (30 sec max.)

Audio error messages can be sent to an operator, providing faster system recovery. Audio output can also be used as a voice guidance system.

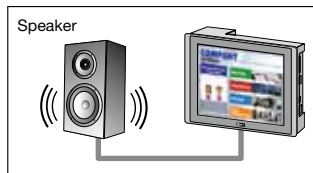

## Ethernet Remote data maintenance

Project data can be downloaded and uploaded remotely via Ethernet. One User can check and operate screens using a PC or smartphone in a remote location.

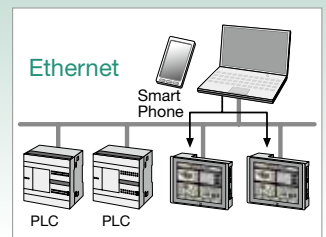

## O/Link IDEC high-speed 115.2 kbps O/Link communication

A maximum of 16 HGs can be connected to a PLC using RS485 (2-wire), easily creating a high-speed network reducing cost.

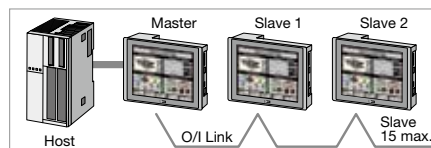

## I/O Module Display and I/O control in one package

A maximum of four MicroSmart expansion modules can be connected, allowing equipment control using a small number of I/O points. (Input, output, I/O modules can be used.)

\* HG4G/3G can connect up to 4, HG2G (high performance model only) can connect up to 2 expansion modules.  
\* For compatible expansion modules, see "Expansion Modules" on page 23.

## Cyclic Script Cyclic I/O control

Cyclic script enables parallel processing of I/O control. Real time I/O processing for high performance.

Conventional model	Display	I/O	Display	I/O	Display	I/O	
HG Series	I/O	Display	I/O	Display	I/O	Display	I/O
	10 to 1000 ms		10 to 1000 ms		10 to 1000 ms		



# Fast & Easy

Stress-Free

3-sec startup



High Speed CPU

Fast start-up

High-speed 400 MHz CPU and unique software technology shorten startup time. Fast start-up allows for easy debugging.

High Speed Data

Fast USB2.0 communication

USB 2.0, high-speed 480 Mbps. Project data can be downloaded and uploaded easily using a PC and USB flash drive.

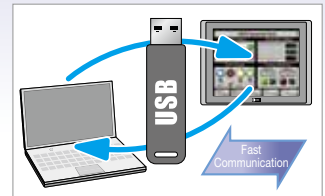

Easy Maintenance

Simple operation



SD Card

Convenient SD card slot

Data can be saved or transferred by using an SD card (32 GB max.) By saving user data on an SD card, user memory can be reduced.

USB Flash Drive

USB flash drive enables easy data transfer.

Inserting a USB flash drive into the HG will automatically bring up the USB transfer menu. Operator can work on errors without the use of a PC.

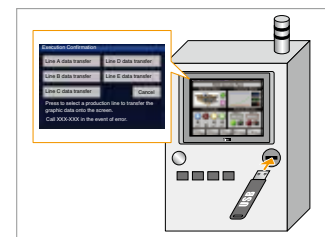

Front Panel Maintenance

Easy data maintenance, without opening the control cabinet.

Using a USB panel-mount cable, data can be transferred without opening the panel. The pass-through function enables debugging of ladder programs in the PLC, connected to the HG, inside the cabinet. \*See the users's manual for compatible PLCs.

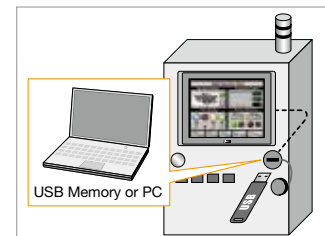

Application Example

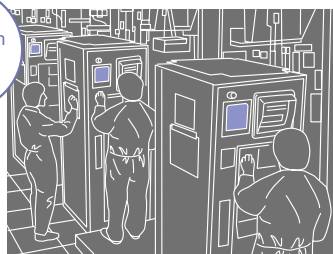

Pict Bridge

USB printer compatible

HG screen information and alarm history can be printed out from Pict Bridge compatible printers.

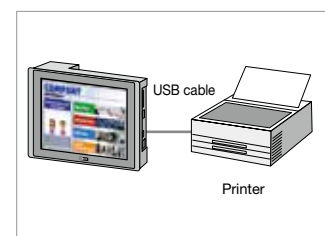



Automation Organizer  
WindO/I-NV2



Automation Organizer  
WindO/I-NV4

(HG2G basic model only)

# OI Touchscreen Programming Software

Flexible and easy to use workspace. Easy programming enables efficiency.

## Dynamic and flexible screen designs

The ribbon organizes commands in groups and tabs, making it possible to find commands easily and quickly.

## Graphic library with extensive collection of images

7000 graphic images can be selected from the library tool. Graphics that are used frequently as part images can be quickly selected from the parts list.

## Easy-to-view work space

Project structure can be listed for easy viewing, and switched to the editing screen in one click.

## Design screens using the object list

Device, operating conditions, and type of command can be read from the object list. During debugging, data stored in the device is shown in popups, and perating conditions can be distinguished via color.

## Easy programming

Operating conditions for buttons and lamps can be programmed in the property settings.

## Create language screens easily

Switch to any of the supported languages by using the text manager within the same project. Translation is easy as Unicode format files can be imported/exported.

## Tag editor shows available devices at a glance

Device addresses used in the project can be easily identified by using the tag editor and cross-references.

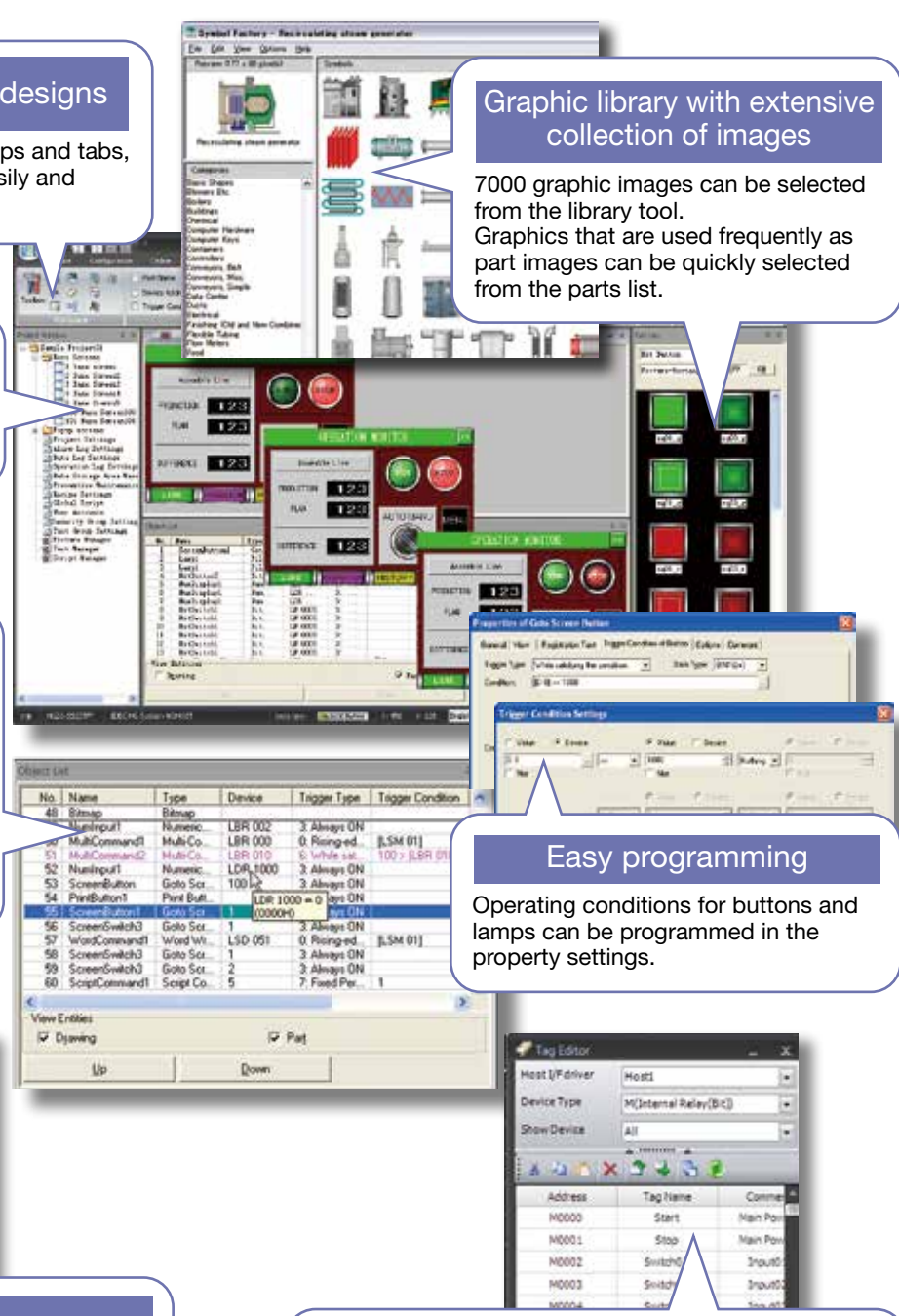

No.	Name	Type	Device	Trigger Type	Trigger Condition
48	Ribmap	Ribmap			
49	MultiInput1	Numeric	LBR 002	3 Always ON	
50	MultiCommand1	Multi-Co.	LBR 000	0 Ringed	[LSM 01]
51	MultiCommand2	Multi-Co.	LBR 010	5 While sat	100 > [LBR 01]
52	MultiInput1	Numeric	LDR 1000	3 Always ON	
53	ScreenButton1	Plant Butt.	LDR 1000	0 Always ON	
54	ScreenButton1	Plant Butt.	LDR 1000	0 Always ON	
55	ScreenSwitch3	Goto Scr.	1	3 Always ON	
56	ScreenSwitch3	Goto Scr.	1	3 Always ON	
57	ScreenSwitch3	Word Wrt.	LSD 051	0 Ringed	[LSM 01]
58	ScreenSwitch3	Goto Scr.	1	3 Always ON	
59	ScreenSwitch3	Goto Scr.	2	3 Always ON	
60	ScriptCommand1	Script Co.	5	7 Fixed Per.	1

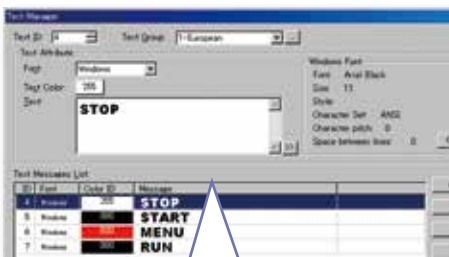

### System Requirements

- Windows 8 (32-bit/64-bit), Windows 7 (32-bit/64-bit), Windows Vista (32 bit/64 bit), Windows XP (32-bit, Service Pack 3 or later) (Ensure that your operating system has the latest update from the Microsoft Windows Update website)
- 1.0 GHz or faster CPU
- Microsoft .NET Framework 4.0
- WindO/I-NV4 can only be used on HG2G basic models.
- 512 MB RAM (1 GB recommended)
- 800 MB hard disk space
- Screen resolution of 1024 x 768 or more
- Mouse, DVD-ROM drive, administrator account

\*Windows is a registered trademark of Microsoft Corporation, USA and other countries.  
\*WindO/I-NV2 and WindO/I-NV4 are included in IDEC's package software "Automation Organizer".



# Environment

Withstands  
Harsh  
Environments

## Excellent environmental resistance



Wide Temp. Range

Operates in a wide temperature range from -20 to +60°C\*

Suitable for use in a wide temperature range from cold to hot environment.  
(\*HG2G basic model only)

Long Life

Long-life LED back light

Long 100,000-hour service reduces maintenance work.

Water proof

IP66 rating (protection against powerful jets) suitable for washdown applications

Touchscreens can be used on machines washed down by water such as food machines.



UV Resistant

Protected against UV

An UV resistant case is used to prevent degradation. An optional protective sheet can be used to prevent the display from becoming cloudy.

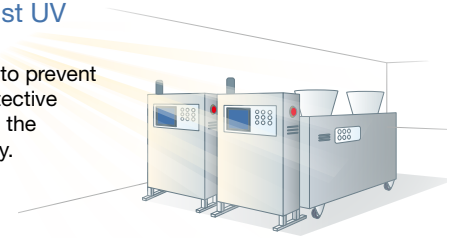

Oil Resistant

IP66f rating prevents ingress of oil.\*

Suitable for use on food machines subject to oil spills.  
(\*HG2G basic model only. Operation is not guaranteed when used with certain types of oils.)

Damage Resistant

Strong Coating

Strong coating protects the touchscreen from scratches.

Degree of Protection

I P 6 6 F  
① ② ③

① [First characteristic numeral] Degree of protection against excess to hazardous parts and protection against external solid objects.  
6 Dust-tight

② [Second characteristic numeral] Degree of protection against water penetration  
5 Protected against water jets  
6 Protected against powerful water jets  
Water projected in powerful jets against the enclosure from any direction shall have no harmful effects.  
7 Protected against the effects of temporary immersion in water Ingress of water shall not be possible when the enclosure is immersed in water up to 1 m for 30 minutes.

③ [Additional letter]  
F Oil resistant\*



# Multimedia

## Multimedia Functions

### Records and plays back high quality images

Multimedia models with video and audio input terminals. The screen records images on an SD card through a connected video camera and images recorded on an SD card can be played back on the screen or PC.

\* HG4G-CJT22MF, HG3G-AJT22MF, HG3G-8JTMF models only.

#### Display

Displays images on the screen from the camera.



#### Save Image

Records and plays back images on the screen from the camera and saves the data on the SD card.

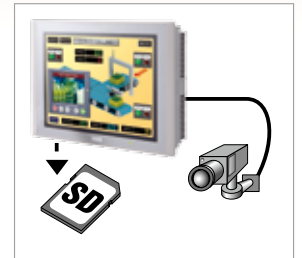

#### Video Play

Replays video images and audio from an SD card.

MPEG4 video files can be played back on the screen. Work procedures can be shown on the screen, and when trouble occurs, it can be used as a video manual for troubleshooting on-site.



#### Video Recording

Records video images of an error

When an alarm is set off, video images before and after the start of the alarm can be recorded on an SD card. This enables on-site analysis of the trouble. Smooth and refined images can be recorded.

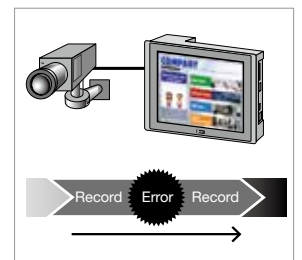

### Application Examples

Find out the cause of an error

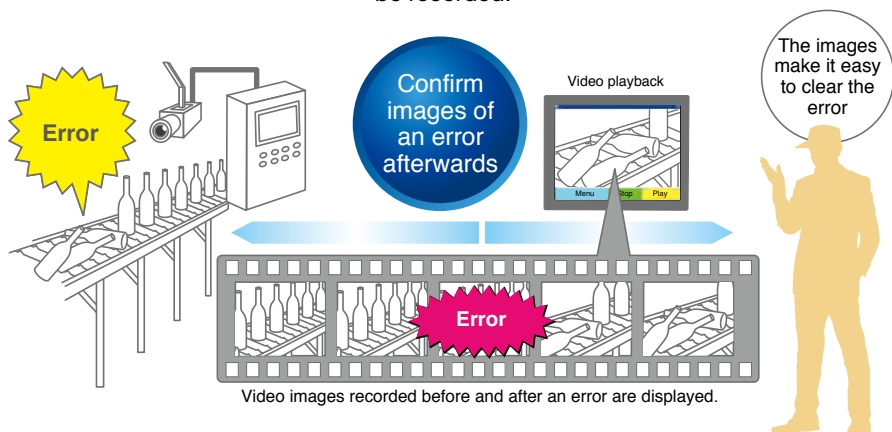

# Human-machine interface expands IDEC

Easy troubleshooting using video images

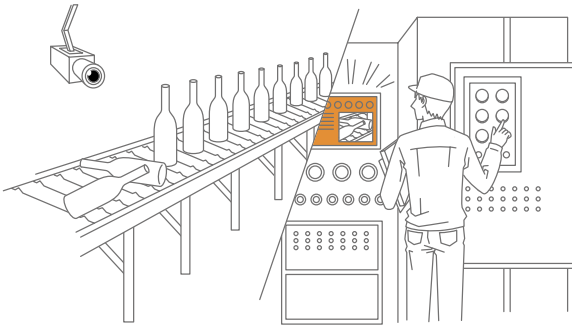

Complicated maintenance can be carried out



## Lineup

## HG series Operator Interface

### High Performance

**HG4G**

12.1 inch

314 × 240 × 54.1 mm  
SVGA (800 × 600)  
TFT65,536 colors

Bright 550 cd/m <sup>2</sup>	LED 100,000 Hours	48-level Brightness Adjustment	Graphics
Stroke Fonts	Serial Interface	Ethernet	USB mini-B
USB A	4 Expansion Modules	Audio Output	O/I Link
Cyclic Script	SD Card	USB Flash Drive	High Speed CPU
High Speed Data	User Memory 12MB	Pict Bridge	Front Panel Maintenance
Audio Input	Video Input	Video Play	Video Recording
Voltage 24V DC	Vertical OK	Bezel Color	Dark gray

**HG3G**

10.4 inch      8.4 inch

270 × 212 × 52.7 mm      231 × 176 × 54.4 mm  
SVGA (800 × 600)      SVGA (800 × 600)  
TFT65,536 colors      TFT65,536 colors

Bright 700 cd/m <sup>2</sup>	Bright 600 cd/m <sup>2</sup>			
LED 100,000 Hours	48-level Brightness Adjustment	Graphics	Stroke Fonts	Serial Interface
Ethernet	USB mini-B	USB A	4 Expansion Modules	Audio Output
O/I Link	Cyclic Script	SD Card	USB Flash Drive	High Speed CPU
High Speed Data	User Memory 12MB	Pict Bridge	Front Panel Maintenance	Audio Input
Video Input	Video Play	Video Recording	Voltage 24V DC	Vertical OK
Bezel Color	Light gray	Dark gray		

**HG2G-5F**

5.7 inch

167.2 × 134.7 × 54.4 mm  
VGA (640 × 480)  
TFT65,536 colors

Bright 800 cd/m <sup>2</sup>	LED 50,000 Hours	48-level Brightness Adjustment	Graphics	
Stroke Fonts	Serial Interface	Ethernet	USB mini-B	
USB A	2 Expansion Modules	O/I Link	Cyclic Script	
SD Card	USB Flash Drive	High Speed CPU	High Speed Data	
User Memory 12MB	Pict Bridge	Front Panel Maintenance	Voltage 24V DC	
Vertical OK	Bezel Color	Light gray	Dark gray	Silver

# network control

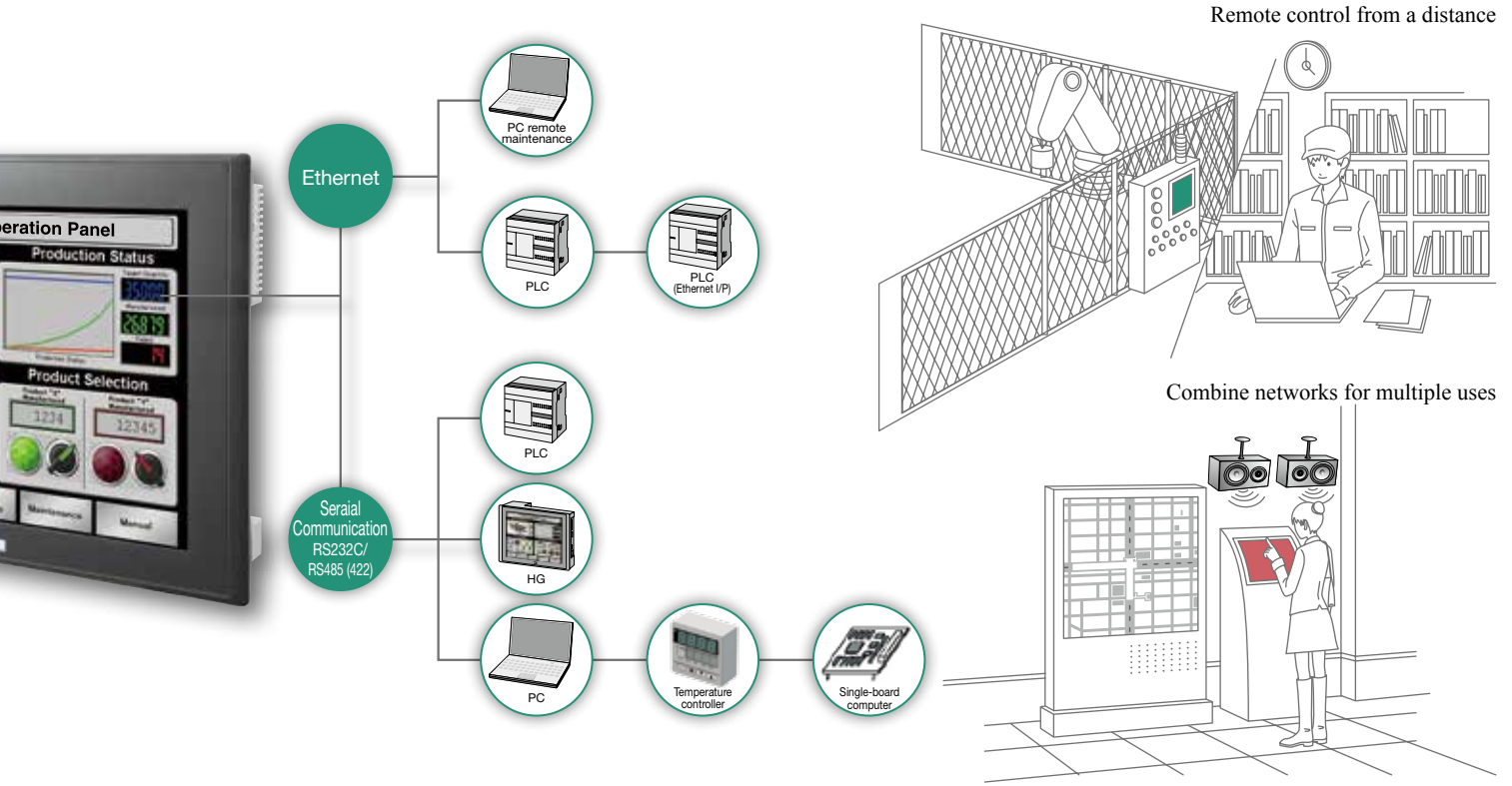

## Basic

### HG2G-5TT

5.7 inch

167.2 × 134.7 × 40.9 mm  
QVGA (320 × 240)  
TFT 65,536 colors

Bright 500 cd/m <sup>2</sup>	LED 100,000 Hours	32-level Brightness Adjustment	Graphics	Stroke Fonts
Serial Interface	Ethernet	USB mini-B	USB A	USB Flash Drive
User Memory 5MB	Front Panel Maintenance	Voltage 12/24V DC	Temp. -20 to +60°C	Vertical OK

Bezel Color: Light gray, Dark gray, Silver

### HG2G-5TN

5.7 inch

167.2 × 134.7 × 40.9 mm  
QVGA (320 × 240)  
TFT monochrome (16 shades)

Bright 1100 cd/m <sup>2</sup>	LED 100,000 Hours	32-level Brightness Adjustment	Stroke Fonts	Serial Interface
Ethernet	USB mini-B	USB A	USB Flash Drive	User Memory 5MB
Front Panel Maintenance	Voltage 12/24V DC	Temp. -20 to +60°C	Vertical OK	

Bezel Color: Light gray, Dark gray, Silver

## Compact

### HG1G

4.3 inch

128 × 102.0 mm  
WQVGA (480 × 272)

Bright 800 cd/m <sup>2</sup>	TFT 65,536 colors	LED 70,000 Hours	32-level Brightness Adjustment	Graphics
Stroke Fonts	WQVGA 480x272	Serial Interface	Ethernet	USB mini-B
USB A	USB Flash Drive	User Memory 12MB	Front Panel Maintenance	Voltage 12/24V DC

Temp. -20 to +55°C, Vertical OK, Bezel Color: Black, Silver

### HG1F

4.6 inch

147 × 76 × 39.3 mm  
(300 × 100)  
STN monochrome (16 shades)

**Sharp & Vivid** Bright LED Brightness Adjustment Graphics Stroke Fonts >> Page 4

**Simple Control** Serial Interface Ethernet USB mini-B USB A Expansion Module Audio Output O/Link Cyclic Script >> Page 5

**Fast & Easy** SD Card USB Flash Drive High Speed CPU High Speed Data User Memory Pict Bridge Front Panel Maintenance >> Page 6

**Environmental** Wide Temp. Range Long Life Water proof UV Resistant Oil Resistant Damage Resistant >> Page 8

**Multimedia** Audio Input Video Input Video Play Video Recording >> Page 9

OI Touchscreen Programming Software >> Page 7

\* See catalog no. EP1589 for HG1G.  
\* See catalog no. EP1128 for HG1F.

# 12.1 inch HG4G Operator Interface

Compact housing with a versatile interface.  
High performance operator interface with multimedia functions.

- Bright 550 cd/m<sup>2</sup>
- TFT 65,536 Colors
- LED 100,000 Hours
- SVGA 800-600
- 48-level Brightness Adjustment
- Graphics
- Stroke Fonts
- Serial Interface
- Ethernet
- USB mini-B
- USB A
- 4 Expansion Modules
- Audio Output
- O/I Link
- Cyclic Script
- SD Card
- USB Flash Drive
- High Speed CPU
- High Speed Data
- User Memory 12MB
- Pict Bridge
- Front Panel Maintenance
- Audio Input
- Video Input
- Video Play
- Video Recording (Note)
- Voltage 24V DC
- Vertical OK
- Bezel Color
- Dark gray

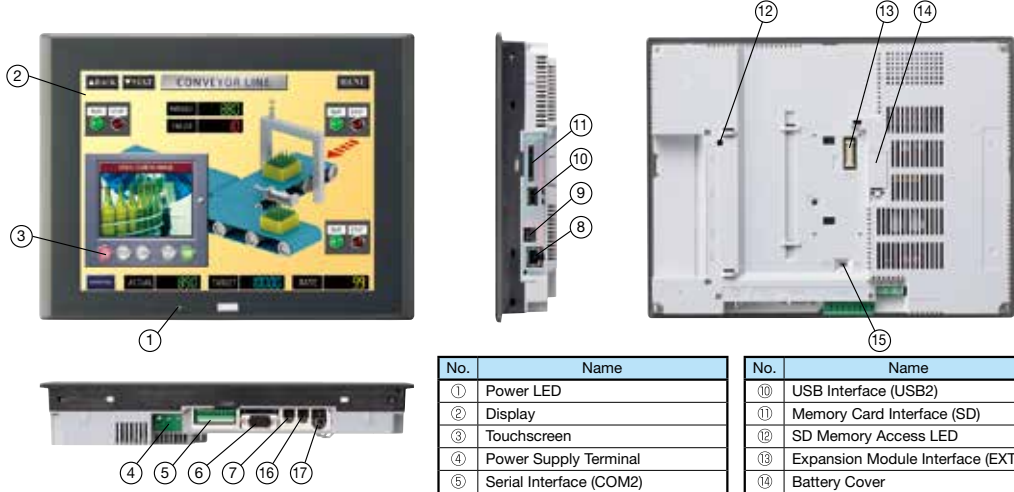

No.	Name
①	Power LED
②	Display
③	Touchscreen
④	Power Supply Terminal
⑤	Serial Interface (COM2)
⑥	Serial Interface (COM1)
⑦	Audio Interface (AUDIO OUT)
⑧	Ethernet Interface (LAN)
⑨	USB Interface (USB1)

No.	Name
⑩	USB Interface (USB2)
⑪	Memory Card Interface (SD)
⑫	SD Memory Access LED
⑬	Expansion Module Interface (EXT)
⑭	Battery Cover
⑮	Terminal Resistor Switch
⑯	Audio Interface (AUDIO IN)
⑰	Video Interface (VIDEO IN)

UL LISTED CE (Approval for HG4G operator interface only, excluding options or expansion modules.)

## HG4G Operator Interface

Display Screen	Operation Style	Communication/Memory Interface	Video/Audio Interface	Housing/Bezel Color	Part No. (Ordering No.)	Approvals
12.1-inch TFT color LCD 65,536 colors	Touch Switch (analog resistive)	COM1 COM2 LAN USB1 USB2 SD Memory Card	VIDEO IN AUDIO IN AUDIO OUT	Dark gray	HG4G-CJT22MF-B	Safety Standards: UL508 CSA C22.2 No.142 CSA C22.2 No.213 ANSI/ISA-12.12.01 Ship Classification Standards: ABS, LR, NK, DNV
			AUDIO OUT	Dark gray	HG4G-CJT22TF-B	

## Dimensions

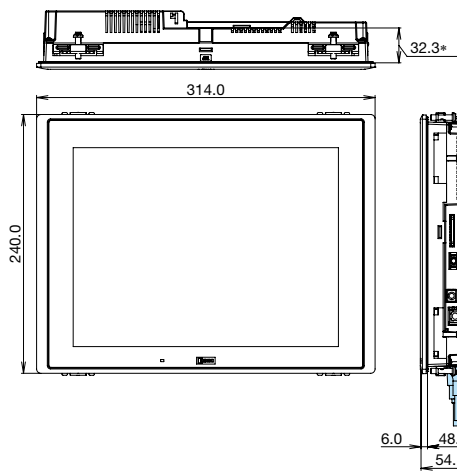

\* Depth from the expansion module mounting surface.

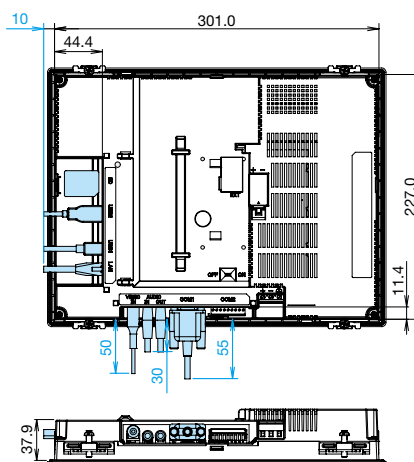

## Panel Cut-out

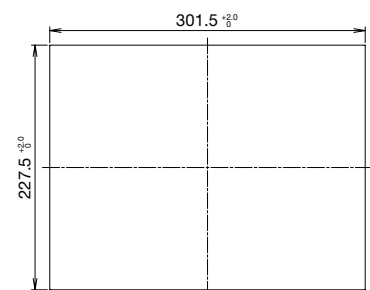

Panel Thickness: 2.0 to 5.0 mm

All dimensions in mm.

Note 1: Dimensions in blue show the mounting dimensions of the cable.

Note 2: Dimensions in the figure may vary depending on the type of cable connected.

Note 3: Install the HG4G into a panel cut-out by tightening the four mounting clips (supplied with the HG4G) to a torque of 0.5 to 0.6 N·m.

Do not tighten with excessive force, otherwise the HG4G and screen may become distorted. Also waterproof characteristics may be lost.

## General Specifications

Rated Power Voltage	24V DC
Power Voltage Range	20.4 to 28.8V DC
Power Consumption	27W maximum 18W maximum when not using USB interface (USB2) or expansion module interface (EXT)
Allowable Momentary Power Interruption	10 ms maximum
Inrush Current	30A maximum
Dielectric Strength	1,000V AC, 10 mA, 1 minute between power and FG terminals
Operating Temperature	0 to +50°C
Operating Humidity	10 to 90% RH (no condensation)
Storage Temperature	-20 to +60°C
Storage Humidity	10 to 90% RH (no condensation)
Pollution Degree	2
Vibration Resistance	5 to 8.4 Hz amplitude 3.5 mm, 8.4 to 150 Hz, acceleration 9.8 m/s <sup>2</sup> 10 cycles (100 minutes) on each of three mutually perpendicular axes
Shock Resistance	147 m/s <sup>2</sup> , 11 ms 5 shocks on each of three mutually perpendicular axes
Noise Immunity	Fast transient/burst test, Power terminals: ±2 kV, Communication line: ±1 kV (IEC/EN61131-2: 2007)
Electrostatic Discharge	Contact ±6 kV, air ±8 kV (IEC/EN61131-2: 2007)
Corrosion Immunity	Free from corrosive gases
Mounting	Panel mounting (Panel Thickness: 2.0 to 5.0 mm)
Degree of Protection	IP66 (IEC 60529) (front part when mounted) *1 TYPE 4X TYPE 13 *2
Dimensions	314.0W × 240.0H × 54.1D mm
Weight (approx.)	2.1 kg

- Do not use the HG4G in an environment subject to strong ultraviolet rays, otherwise the LCD quality will deteriorate.
- \*1 Protection degree of the front surface after mounting. Operation not guaranteed under certain environments.
- \*2 Operation not guaranteed when used with certain types of oils.

## Display Specifications

Display	TFT Color LCD	
Color/Shade	65,536 colors	
Effective Display Area	246.0W × 184.5H mm	
Display Resolution	800W × 600H pixels	
View Angle	Right and left 80°, up 80°, down 60°	
Backlight	LED	
Backlight Life	100,000 hours minimum *1	
Brightness	550 cd/m <sup>2</sup> *2	
Brightness Adjustment	48 levels	
Backlight Replacement	Not possible	
Display Character Size	1/4 size	8 × 8 pixels (Western European language: ISO 8859-1, Central European language: ANSI 1250, Baltic: ANSI 1257, Cyrillic: ANSI1251, Japanese katakana and symbols: JIS 8-bit code)
	1/2 size	8 × 16 pixels (Western European language: ISO 8859-1, Central European language: ANSI 1250, Baltic: ANSI 1257, Cyrillic: ANSI1251, Japanese katakana and symbols: JIS 8-bit code) 16 × 32 pixels, 24 × 48 pixels, 32 × 64 pixels (Western European language: ISO 8859-1)
	Full size	16 × 16 pixels (Japanese JIS first and second level characters, simplified Chinese, traditional Chinese, Korean)
	Double size	32 × 32 pixels (Japanese JIS first level characters, Mincho font)
	Scalable	Width 8 to 128 dots (1/2 size fixed) (ISO 8859-1 western language, 7-segment)
Quantity of Characters	1/4 size	100 characters × 75 lines
	1/2 size	100 characters × 37 lines
	Full size	50 characters × 37 lines
	Double size	25 characters × 18 lines (Mincho font)
Character Magnification	0.5, 1 to 8 vertically and horizontally (except for scalable fonts)	
Character Attribute	Blink (1 or 0.5 sec period), reverse, bold, shadowed	
Graphics	Straight line, polyline, rectangle, circle, ellipse, arc, pie, equilateral polygons (3, 4, 5, 6, 8), paint, bitmap image	
Window Display	3 popup screens + 1 system screen	

- \*1 The backlight life is not guaranteed and refers to the time until the brightness reduces by half after use at 25°C. The actual life depends on operating environments and conditions.
- \*2 Brightness of the LCD only.

## Operation Specifications

Switching Element	Analog resistive membrane
Operating Force	3N maximum
Mechanical Life	1,000,000 operations
Acknowledgement Sound	Electronic buzzer or speaker output

## Function Specifications

Screen Types	Base screen, popup screen, system screen
No. of Screens	Base screen: 3,000 max. Popup screen: 3,015 max.
User Memory	12 MB (including expansion fonts)
Parts	Bit Button, Word Button, Goto Screen, Print Button, Key Button, Multi Button, Keypad, Selector Switch, Potentiometer, Numerical Input, Character Input, Pilot Lamp, Multi-State Lamp, Picture Display, Message Display, Message Switching Display, Alarm List Display, Alarm Log Display, Numerical Display, Bar Graph, Trend Chart, Pie Chart, Meter, Calendar, Bit Write Command, Word Write Command, Goto Screen Command, Print Command, Timer, Screen Script Command, Multi Command, Video Display
Calendar	Year, Month, Day, Hour, Min., Sec., Day of Week ±60 sec per month (at 25°C)
Power Failure Backup Data	Calendar, log data, keep internal relay, keep internal register
Battery	Recommended replacement span: every 5 years (at 25°C)

## Interface Specifications

Serial Interface (COM1)	Electrical Characteristics	EIA RS232C, RS422/485 compliant
	Transmission Speed	1200, 2400, 4800, 9600, 19200, 38400, 57600, 115200, 187500 bps (Note)
	Synchronization	Asynchronous
	Communication Method	Half or full duplex
	Control System	Hardware control or none
	Connector	D-sub 9-pin connector
Serial Interface (COM2)	Electrical Characteristics	EIA RS232C, RS422/485 compliant
	Transmission Speed	1200, 2400, 4800, 9600, 19200, 38400, 57600, 115200, 187500 bps (Note)
	Synchronization	Asynchronous
	Communication Method	Half or full duplex
	Control System	Hardware control or none
	Connector	Detachable 9-pin terminal block
Ethernet Interface (LAN)	Interface	IEEE802.3u (10/100BASE-T) compliant
	Connector	Modular connector (RJ-45)
Video Interface (VIDEO IN)	Interface	NTSC/PAL
	Connector	Pin jack
Audio Interface (AUDIO IN)	Interface	LINE IN (stereo)
	Connector	Mini jack connector (ø3.5 mm)
Audio Interface (AUDIO OUT)	Interface	LINE OUT (stereo)
	Connector	Mini jack connector (ø3.5 mm)
USB Interface (USB2)	Interface	USB 2.0 high speed (480 Mbps)
	Connector	USB Type A connector
USB Interface (USB1)	Interface	USB 2.0 high speed (480 Mbps)
	Connector	USB Type Mini-B connector
Memory Card Interface (SD)	Interface	SD memory card, SDHC memory card
	Connector	SD memory card socket
Expansion Module Interface (EXT)	Interface	MicroSmart I/O module interface
	Output current	5V 130 mA 24V 150 mA
	Max. no. of units	4 units

Note: 187,500 bps is available only with SIEMENS SIMATIC S7-300/400 series (MPI port direct connection).

# HG3G Operator Interface

10.4  
inch

Excellent visibility by super-bright LED backlight.  
700 cd/m<sup>2</sup> (10.4-inch)

Bright 700 cd/m <sup>2</sup>	TFT 65,536 Colors	LED 100,000 Hours	SVGA 800×600
48-level Brightness Adjustment	Graphics	Stroke Fonts	Serial Interface
Ethernet	USB mini-B	USB A	4 Expansion Modules
Audio Output	O/I Link	Cyclic Script	SD Card
USB Flash Drive	High Speed CPU	High Speed Data	User Memory 12MB
Pict Bridge	Front Panel Maintenance	Audio Input	Video Input
Video Play	Video Recording (Note)	Voltage 24V DC	Vertical OK

Bezel Color:  Light Gray  Dark Gray

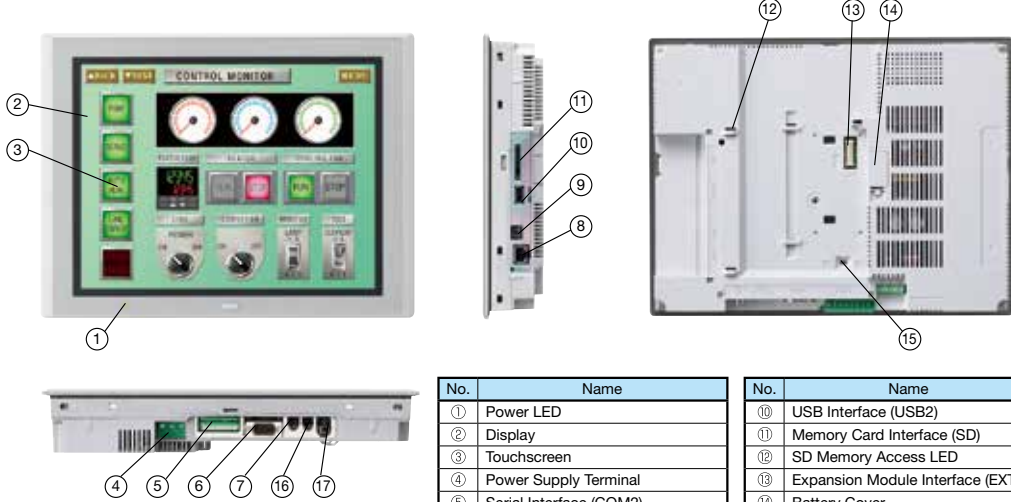

No.	Name
①	Power LED
②	Display
③	Touchscreen
④	Power Supply Terminal
⑤	Serial Interface (COM2)
⑥	Serial Interface (COM1)
⑦	Audio Interface (AUDIO OUT)
⑧	Ethernet Interface (LAN)
⑨	USB Interface (USB1)

No.	Name
⑩	USB Interface (USB2)
⑪	Memory Card Interface (SD)
⑫	SD Memory Access LED
⑬	Expansion Module Interface (EXT)
⑭	Battery Cover
⑮	Terminal Resistor Switch
⑯	Audio Interface (AUDIO IN)
⑰	Video Interface (VIDEO IN)

(Approval for HG3G operator interface only, excluding options or expansion modules.)

## HG3G Operator Interface

Display Screen	Operation Style	Communication/Memory Interface	Video/Audio Interface	Housing/Bezel Color	Part No. (Ordering No.)	Approvals
10.4-inch TFT color LCD 65,536 colors	Touch Switch (analog resistive)	COM1 COM2 LAN USB1 USB2 SD Memory Card	VIDEO IN AUDIO IN AUDIO OUT	Light gray	HG3G-AJT22MF-W	Safety Standards: UL508 CSA C22.2 No.142 CSA C22.2 No.213 ANSI/ISA-12.12.01  Ship Classification Standards: ABS, LR, NK, DNV
				Dark gray	HG3G-AJT22MF-B	
			AUDIO OUT	Light gray	HG3G-AJT22TF-W	
				Dark gray	HG3G-AJT22TF-B	

## Dimensions

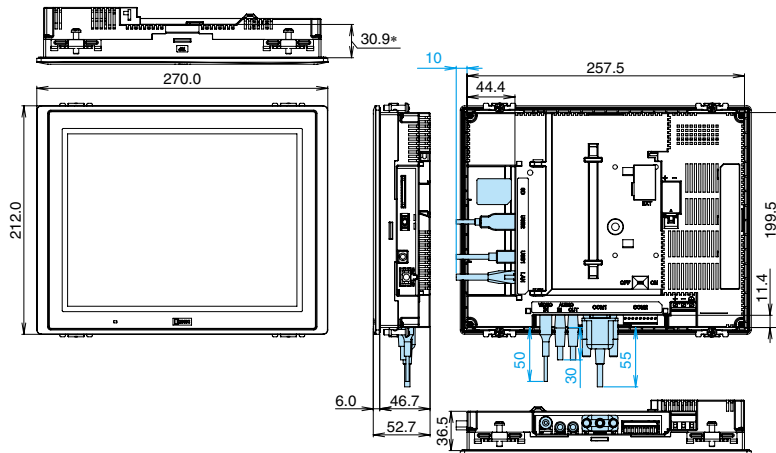

\* Depth from the expansion module mounting surface.

## Panel Cut-out

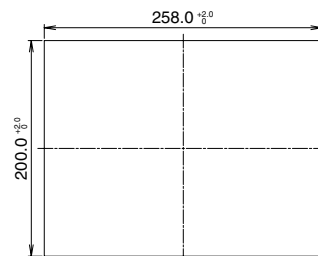

Panel Thickness: 2.0 to 5.0 mm

All dimensions in mm.

Note 1: Dimensions in blue show the mounting dimensions of the cable.

Note 2: Dimensions in the figure vary depending on the type of cable connected.

Note 3: Install the HG3G into a panel cut-out by tightening the four mounting clips (supplied) to a torque of 0.5 to 0.6 N·m.

Do not tighten with excessive force, otherwise the HG3G and screen may be distorted. Also waterproof characteristics may be lost.

## General Specifications

Model	HG3G-A (10.4 inch)
Rated Power Voltage	24V DC
Power Voltage Range	20.4 to 28.8V DC
Power Consumption	25W maximum 15W maximum when not using USB interface (USB2) or expansion module interface (EXT)
Allowable Momentary Power Interruption	10 ms maximum
Inrush Current	30A maximum
Dielectric Strength	1,000V AC, 10 mA, 1 minute between power and FG terminals
Operating Temperature	0 to +50°C
Operating Humidity	10 to 90% RH (no condensation)
Storage Temperature	-20 to +60°C
Storage Humidity	10 to 90% RH (no condensation)
Pollution Degree	2
Vibration Resistance	5 to 8.4 Hz amplitude 3.5 mm, 8.4 to 150 Hz, acceleration 9.8 m/s <sup>2</sup> 10 cycles (100 minutes) on each of three mutually perpendicular axes
Shock Resistance	147 m/s <sup>2</sup> , 11 ms 5 shocks on each of three mutually perpendicular axes
Noise Immunity	Fast transient/burst test, Power terminals: ±2 kV, Communication line: ±1 kV (IEC/EN 61131-2: 2007)
Electrostatic Discharge	Contact ±6 kV, air ±8 kV (IEC/EN 61131-2: 2007)
Corrosion Immunity	Free from corrosive gases
Mounting	Panel mounting (Panel Thickness: 2.0 to 5.0 mm)
Degree of Protection	IP66 (IEC 60529) (front part when mounted) *1 TYPE 4X TYPE 13 *2
Dimensions	270.0W × 212.0H × 52.7D mm
Weight (approx.)	1.65 kg

- Do not use the HG3G in an environment subject to strong ultraviolet rays, otherwise the LCD quality will deteriorate.
- \*1 Protection degree of the front surface after mounting. Operation not guaranteed under certain environments.
- \*2 Operation not guaranteed when used with certain types of oils.

## Display Specifications

Model	HG3G-A (10.4 inch)	
Display Color	TFT Color LCD	
Color/Shade	65,536 colors	
Effective Display Area	211.2 W × 158.4 H mm	
Display Resolution	800 W × 600 H pixels	
View Angle	Right and left 80°, up 80°, down 60°	
Backlight	LED	
Backlight Life	100,000 hours minimum *1	
Brightness	700 cd/m <sup>2</sup> *2	
Brightness Adjustment	48 levels	
Backlight Replacement	Not possible	
Display Character Size	1/4 size	8 × 8 pixels (Western European language: ISO 8859-1, Central European language: ANSI 1250, Baltic: ANSI 1257, Cyrillic: ANSI1251, Japanese katakana and symbols: JIS 8-bit code)
	1/2 size	8 × 16 pixels (Western European language ISO 8859-1, Central European language: ANSI 1250, Baltic: ANSI 1257, Cyrillic: ANSI1251, Japanese katakana and symbols: JIS 8-bit code)
	Full size	16 × 32 pixels, 24 × 48 pixels, 32 × 64 pixels (Western European language: ISO 8859-1)
	Double size	16 × 16 pixels (Japanese JIS first and second level characters, simplified Chinese, traditional Chinese, Korean)
	Double size	32 × 32 pixels (Japanese JIS first level characters, Mincho font)
	Scalable	Width 8 to 128 dots (1/2 size fixed) (ISO 8859-1 western language, 7-segment)
Quantity of Characters	1/4 size	100 characters × 75 lines
	1/2 size	100 characters × 37 lines
	Full size	50 characters × 37 lines
	Double size	25 characters × 18 lines (Mincho font)
Character Magnification	0.5, 1 to 8 vertically and horizontally (except for scalable fonts)	
Character Attribute	Blink (1 or 0.5 sec period), reverse, bold, shadowed	
Graphics	Straight line, polyline, rectangle, circle, ellipse, arc, pie, equilateral polygons (3, 4, 5, 6, 8), paint, bitmap image	
Window Display	3 popup screens + 1 system screen	

- \*1 The backlight life is not guaranteed and refers to the time until the brightness reduces by half after use at 25°C. The actual life depends on operating environments and conditions.
- \*2 Brightness of the LCD only.

## Operation Specifications

Switching Element	Analog resistive membrane
Operating Force	0.55 to 2.3N
Mechanical Life	1,000,000 operations
Acknowledgement Sound	Electronic buzzer or speaker output

## Function Specifications

Screen Types	Base screen, popup screen, system screen
No. of Screens	Base screen: 3,000 max. Popup screen: 3,015 max.
User Memory	12 MB (including expansion fonts)
Parts	Bit Button, Word Button, Goto Screen, Print Button, Key Button, Multi Button, Keypad, Selector Switch, Potentiometer, Numerical Input, Character Input, Pilot Lamp, Multi-State Lamp, Picture Display, Message Display, Message Switching Display, Alarm List Display, Alarm Log Display, Numerical Display, Bar Graph, Trend Chart, Pie Chart, Meter, Calendar, Bit Write Command, Word Write Command, Goto Screen Command, Print Command, Timer, Screen Script Command, Multi Command, Video Display
Calendar	Year, Month, Day, Hour, Min., Sec., Day of Week ±60 sec per month (at 25°C)
Power Failure Backup Data	Calendar, log data, keep internal relay, keep internal register
Battery	Recommended replacement span: every 5 years (at 25°C)

## Interface Specifications

Serial Interface (COM1)	Electrical Characteristics	EIA RS232C, RS422/485 compliant
	Transmission Speed	1200, 2400, 4800, 9600, 19200, 38400, 57600, 115200, 187500 bps (Note)
	Synchronization	Asynchronous
	Communication Method	Half or full duplex
Serial Interface (COM2)	Control System	Hardware control or none
	Connector	D-sub 9-pin connector
	Electrical Characteristics	EIA RS232C, RS422/485 compliant
	Transmission Speed	1200, 2400, 4800, 9600, 19200, 38400, 57600, 115200, 187500 bps (Note)
Ethernet Interface (LAN)	Synchronization	Asynchronous
	Communication Method	Half or full duplex
	Control System	Hardware control or none
	Connector	Detachable 9-pin terminal block
Ethernet Interface (LAN)	Interface	IEEE802.3 (10/100BASE-T) compliant
	Connector	Modular connector (RJ-45)
Video Interface (VIDEO IN)	Interface	NTSC/PAL
	Connector	Pin jack
Audio Interface (AUDIO IN)	Interface	LINE IN (stereo)
	Connector	Mini jack connector (ø3.5 mm)
Audio Interface (AUDIO OUT)	Interface	LINE OUT (stereo)
	Connector	Mini jack connector (ø3.5 mm)
USB Interface (USB2)	Interface	USB 2.0 high speed (480 Mbps)
	Connector	USB Type A connector
USB Interface (USB1)	Interface	USB 2.0 high speed (480 Mbps)
	Connector	USB Type Mini-B connector
Memory Card Interface (SD)	Interface	SD memory card, SDHC memory card
	Connector	SD memory card socket
Expansion Module Interface (EXT)	Interface	MicroSmart I/O module interface
	Output current	5V 130 mA 24V 150 mA
	Max. no. of units	4 units

Note: 187,500 bps is available only with SIEMENS SIMATIC S7-300/400 series (MPI port direct connection).

8.4  
inch

# HG3G Operator Interface

Excellent visibility by super-bright LED backlight.  
600 cd/m<sup>2</sup> (8.4-inch)

Bright 600 cd/m <sup>2</sup>	TFT 65,536 Colors	LED 100,000 Hours	SVGA 800-600
48-level Brightness Adjustment	Graphics	Stroke Fonts	Serial Interface
Ethernet	USB mini-B	USB A	4 Expansion Modules
Audio Output	O/I Link	Cyclic Script	SD Card
USB Flash Drive	High Speed CPU	High Speed Data	User Memory 12MB
Pict Bridge	Front Panel Maintenance	Audio Input	Video Input
Video Play	Video Recording (Note)	Voltage 24V DC	Vertical OK

Bezel Color:  Light Gray  Dark Gray

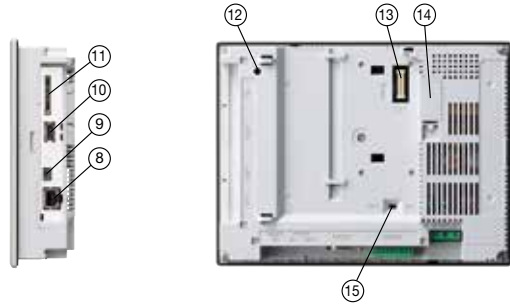
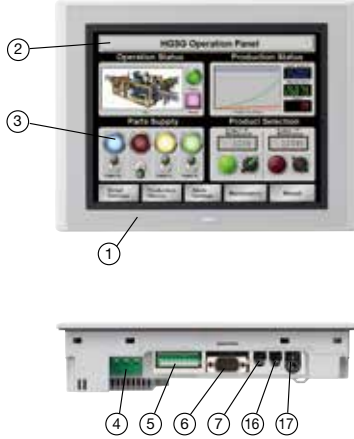

No.	Name
①	Power LED
②	Display
③	Touchscreen
④	Power Supply Terminal
⑤	Serial Interface (COM2)
⑥	Serial Interface (COM1)
⑦	Audio Interface (AUDIO OUT)
⑧	Ethernet Interface (LAN)
⑨	USB Interface (USB1)

No.	Name
⑩	USB Interface (USB2)
⑪	Memory Card Interface (SD)
⑫	SD Memory Access LED
⑬	Expansion Module Interface (EXT)
⑭	Battery Cover
⑮	Terminal Resistor Switch
⑯	Audio Interface (AUDIO IN)
⑰	Video Interface (VIDEO IN)

(Approval for HG3G operator interface only, excluding options or expansion modules.)

## HG3G Operator Interface

Display Screen	Operation Style	Communication/Memory Interface	Video/Audio Interface	Housing/Bezel Color	Part No. (Ordering No.)	Approvals
8.4-inch TFT color LCD 65,536 colors	Touch Switch (analog resistive)	COM1 COM2 LAN USB1 USB2 SD Memory Card	VIDEO IN AUDIO IN AUDIO OUT	Light gray	HG3G-8JT22MF-W	Safety Standards: UL508 CSA C22.2 No.142 CSA C22.2 No.213 ANSI/ISA-12.12.01-2007  Ship Classification Standards: ABS, LR, NR, DNV
				Dark gray	HG3G-8JT22MF-B	
			AUDIO OUT	Light gray	HG3G-8JT22TF-W	
				Dark gray	HG3G-8JT22TF-B	

## Dimensions

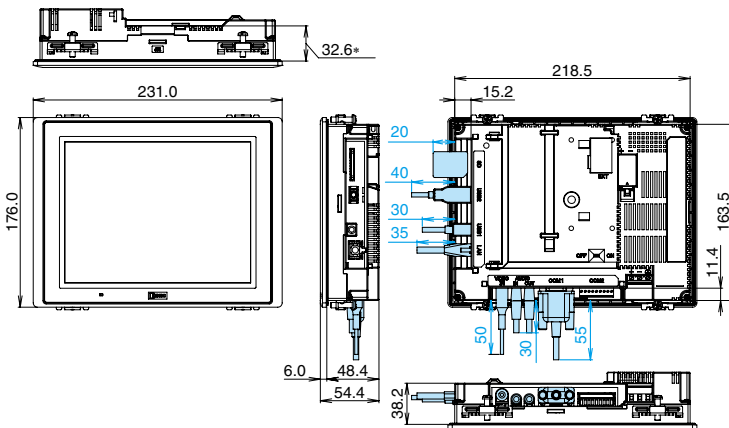

\*Depth from the expansion module mounting surface.

## Panel Cut-out

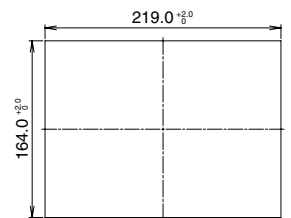

Panel Thickness: 2.0 to 5.0 mm

All dimensions in mm.

Note 1: Dimensions in blue show the mounting dimensions of the cable.

Note 2: Dimensions in the figure vary depending on the type of cable connected.

Note 3: Install the HG3G into a panel cut-out by tightening the four mounting clips (supplied) to a torque of 0.5 to 0.6 N-m.

Do not tighten with excessive force, otherwise the HG3G and screen may be distorted. Also waterproof characteristics may be lost.



## General Specifications

Model	HG3G-8 (8.4 inch)
Rated Power Voltage	24V DC
Power Voltage Range	20.4 to 28.8V DC
Power Consumption	25W maximum 15W maximum when not using USB interface (USB2) or expansion module interface (EXT)
Allowable Momentary Power Interruption	10 ms maximum
Inrush Current	30A maximum
Dielectric Strength	1,000V AC, 10 mA, 1 minute between power and FG terminals
Operating Temperature	0 to +50°C
Operating Humidity	10 to 90% RH (no condensation)
Storage Temperature	-20 to +60°C
Storage Humidity	10 to 90% RH (no condensation)
Pollution Degree	2
Vibration Resistance	5 to 8.4 Hz amplitude 3.5 mm, 8.4 to 150 Hz, acceleration 9.8 m/s <sup>2</sup> 10 cycles (100 minutes) on each of three mutually perpendicular axes
Shock Resistance	147 m/s <sup>2</sup> , 11 ms 5 shocks on each of three mutually perpendicular axes
Noise Immunity	Fast transient/burst test, Power terminals: ±2 kV, Communication line: ±1 kV (IEC/EN 61131-2: 2007)
Electrostatic Discharge	Contact ±6 kV, air ±8 kV (IEC/EN 61131-2: 2007)
Corrosion Immunity	Free from corrosive gases
Mounting	Panel mounting (Panel Thickness: 2.0 to 5.0 mm)
Degree of Protection	IP66 (IEC 60529) (front part when mounted) *1 TYPE 4X TYPE 13 *2
Dimensions	231.0W × 176.0H × 54.4D mm
Weight (approx.)	1.25 kg

- Do not use the HG3G in an environment subject to strong ultraviolet rays, otherwise the LCD quality will deteriorate.
- \*1 Protection degree of the front surface after mounting. Operation not guaranteed under certain environments.
- \*2 Operation not guaranteed when used with certain types of oils.

## Display Specifications

Model	HG3G-8 (8.4 inch)	
Display	TFT Color LCD	
Color/Shade	65,536 colors	
Effective Display Area	170.4W × 127.8H mm	
Display Resolution	800W × 600H pixels	
View Angle	Right and left 80°, up 80°, down 60°	
Backlight	LED	
Backlight Life	100,000 hours minimum *1	
Brightness	600 cd/m <sup>2</sup> *2	
Brightness Adjustment	48 levels	
Backlight Replacement	Not possible	
Display Character Size	1/4 size	8 × 8 pixels (Western European language: ISO 8859-1, Central European language: ANSI 1250, Baltic: ANSI 1257, Cyrillic: ANSI1251, Japanese katakana and symbols: JIS 8-bit code)
	1/2 size	8 × 16 pixels (Western European language: ISO 8859-1, Central European language: ANSI 1250, Baltic: ANSI 1257, Cyrillic: ANSI1251, Japanese katakana and symbols: JIS 8-bit code)
	Full size	16 × 32 pixels, 24 × 48 pixels, 32 × 64 pixels (Western European language: ISO 8859-1)
	Double size	32 × 32 pixels (Japanese JIS first level characters, Mincho font)
	Scalable	Width 8 to 128 dots (1/2 size fixed) (ISO 8859-1 western language, 7-segment)
Quantity of Characters	1/4 size	100 characters × 75 lines
	1/2 size	100 characters × 37 lines
	Full size	50 characters × 37 lines
	Double size	25 characters × 18 lines (Mincho font)
Character Magnification	0.5, 1 to 8 vertically and horizontally (except for scalable fonts)	
Character Attribute	Blink (1 or 0.5 sec period), reverse, bold, shadowed	
Graphics	Straight line, polyline, rectangle, circle, ellipse, arc, pie, equilateral polygons (3, 4, 5, 6, 8), paint, bitmap image	
Window Display	3 popup screens + 1 system screen	

- \*1 The backlight life is not guaranteed and refers to the time until the brightness reduces by half after use at 25°C. The actual life depends on operating environments and conditions.
- \*2 Brightness of the LCD only.

## Operation Specifications

Switching Element	Analog resistive membrane
Operating Force	0.55 to 2.3N
Mechanical Life	1,000,000 operations
Acknowledgement Sound	Electronic buzzer or speaker output

## Function Specifications

Screen Types	Base screen, popup screen, system screen
No. of Screens	Base screen: 3,000 max. Popup screen: 3,015 max.
User Memory	12 MB (including expansion fonts)
Parts	Bit Button, Word Button, Goto Screen, Print Button, Key Button, Multi Button, Keypad, Selector Switch, Potentiometer, Numerical Input, Character Input, Pilot Lamp, Multi-State Lamp, Picture Display, Message Display, Message Switching Display, Alarm List Display, Alarm Log Display, Numerical Display, Bar Graph, Trend Chart, Pie Chart, Meter, Calendar, Bit Write Command, Word Write Command, Goto Screen Command, Print Command, Timer, Screen Script Command, Multi Command, Video Display
Calendar	Year, Month, Day, Hour, Min., Sec., Day of Week ±60 sec per month (at 25°C)
Power Failure Backup Data	Calendar, log data, keep internal relay, keep internal register
Battery	Recommended replacement span: every 5 years (at 25°C)

## Interface Specifications

Serial Interface (COM1)	Electrical Characteristics	EIA RS232C, RS422/485 compliant
	Transmission Speed	1200, 2400, 4800, 9600, 19200, 38400, 57600, 115200, 187500 bps (Note)
	Synchronization	Asynchronous
	Communication Method	Half or full duplex
	Control System	Hardware control or none
Connector	D-sub 9-pin connector	
Serial Interface (COM2)	Electrical Characteristics	EIA RS232C, RS422/485 compliant
	Transmission Speed	1200, 2400, 4800, 9600, 19200, 38400, 57600, 115200, 187500 bps (Note)
	Synchronization	Asynchronous
	Communication Method	Half or full duplex
	Control System	Hardware control or none
Connector	Detachable 9-pin terminal block	
Ethernet Interface (LAN)	Interface	IEEE802.3u (10/100BASE-T) compliant
	Connector	Modular connector (RJ-45)
Video Interface (VIDEO IN)	Interface	NTSC/PAL
	Connector	Pin jack
Audio Interface (AUDIO IN)	Interface	LINE IN (stereo)
	Connector	Mini jack connector (ø3.5 mm)
Audio Interface (AUDIO OUT)	Interface	LINE OUT (stereo)
	Connector	Mini jack connector (ø3.5 mm)
USB Interface (USB2)	Interface	USB 2.0 high speed (480 Mbps)
	Connector	USB Type A connector
USB Interface (USB1)	Interface	USB 2.0 high speed (480 Mbps)
	Connector	USB Type Mini-B connector
Memory Card Interface (SD)	Interface	SD memory card, SDHC memory card
	Connector	SD memory card socket
Expansion Module Interface (EXT)	Interface	MicroSmart I/O module interface
	Output current	5V 130 mA 24V 150 mA
	Max. no. of units	4 units

Note: 187,500 bps is available only with SIEMENS SIMATIC S7-300/400 series (MPI port direct connection).

5.7  
inch

# HG2G Operator Interface (High Performance)

Excellent visibility by super-bright LED backlight.  
800 cd/m<sup>2</sup> (5.7-inch)

Bright 800 cd/m <sup>2</sup>	TFT 65,536 Colors	LED 50,000 Hours	SVGA 640×480
48-level Brightness Adjustment	Graphics	Stroke Fonts	Serial Interface
Ethernet	USB mini-B	USB A	2 Expansion Modules
O/Link	Cyclic Script	SD Card	USB Flash Drive
High Speed CPU	High Speed Data	User Memory 12MB	Pict Bridge
Front Panel Maintenance	Voltage 24V DC	Vertical OK	

Bezel Color: Light Gray, Dark gray, Silver

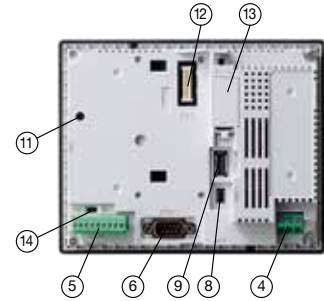
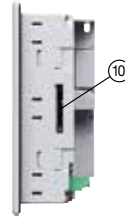
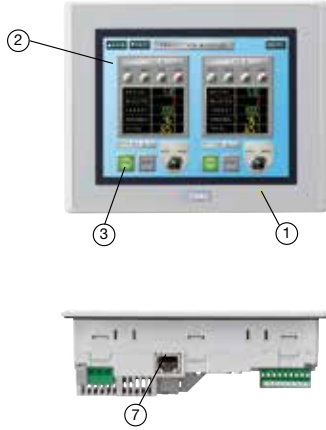

No.	Name
①	Power LED
②	Display
③	Touchscreen
④	Power Supply Terminal
⑤	Serial Interface (COM2)
⑥	Serial Interface (COM1)
⑦	Ethernet Interface (LAN)

No.	Name
⑧	USB Interface (USB1)
⑨	USB Interface (USB2)
⑩	Memory Card Interface (SD)
⑪	SD Memory Access LED
⑫	Expansion Module Interface (EXT)
⑬	Battery Cover
⑭	Terminal Resistor Switch

UL LISTED (Approval for HG2G operator interface only, excluding options or expansion modules.)

## HG2G Operator Interface

Display Screen	Operation Style	Communication/Memory Interface	Housing/Bezel Color	Part No. (Ordering No.)	Approvals
5.7-inch TFT color LCD 65,536 colors	Touch Switch (analog resistive)	COM1 COM2 LAN USB 1 USB 2 SD Memory Card	Light gray	HG2G-5FT22TF-W	Safety Standards: UL508 CSA C22.2 No.142 CSA C22.2 No.213 ANSI/ISA-12.12.01 Ship Classification Standards: ABS, LR, NK, DNV
			Dark gray	HG2G-5FT22TF-B	
			Silver	HG2G-5FT22TF-S	

## Dimensions

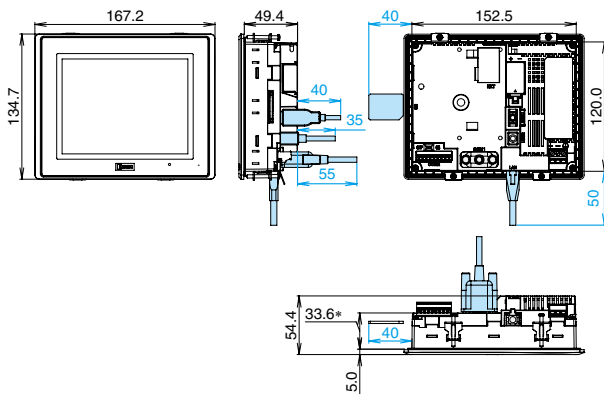

## Panel Cut-out

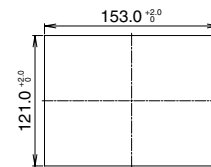

Panel Thickness: 1.6 to 5.0 mm

All dimensions in mm.

\*Depth from the expansion module mounting surface.

- Note 1: Dimensions in blue show the mounting dimensions of the cable.
- Note 2: Dimensions in the figure vary depending on the type of cable connected.
- Note 3: Install the HG2G into a panel cut-out by tightening the four mounting clips (supplied) to a torque of 0.2 to 0.3 N·m.  
Do not tighten with excessive force, otherwise the HG2G and screen may be distorted. Also waterproof characteristics may be lost.

# HG2G Operator Interface (High Performance)

## General Specifications

Rated Power Voltage	24V DC
Power Voltage Range	20.4 to 28.8V DC
Power Consumption	19W maximum 10W maximum when not using USB interface (USB2) or expansion module interface (EXT)
Allowable Momentary Power Interruption	10 ms maximum
Inrush Current	30A maximum
Dielectric Strength	1,000V AC, 10 mA, 1 minute between power and FG terminals
Operating Temperature	0 to +50°C
Operating Humidity	10 to 90% RH (no condensation)
Storage Temperature	-20 to +60°C
Storage Humidity	10 to 90% RH (no condensation)
Pollution Degree	2
Vibration Resistance	5 to 8.4 Hz amplitude 3.5 mm, 8.4 to 150 Hz, acceleration 9.8 m/s <sup>2</sup> 10 cycles (100 minutes) on each of three mutually perpendicular axes
Shock Resistance	147 m/s <sup>2</sup> , 11 ms 5 shocks on each of three mutually perpendicular axes
Noise Immunity	Fast transient/burst test, Power terminals: ±1 kV, Communication line: ±0.5 kV (IEC/EN 61131-2: 2007)
Electrostatic Discharge	Contact ±6 kV, air ±8 kV (IEC/EN 61131-2: 2007)
Corrosion Immunity	Free from corrosive gases
Mounting	Panel mounting (Panel Thickness: 1.0 to 5.0 mm)
Degree of Protection	IP66 (IEC 60529) (front part when mounted) *1 TYPE 4X TYPE 13 *2
Dimensions	167.2W × 134.7H × 54.4D mm
Weight (approx.)	0.65 kg

- Do not use the HG2G in an environment subject to strong ultraviolet rays, otherwise the LCD quality will deteriorate.
- \*1 Protection degree of the front surface after mounting. Operation not guaranteed under certain environments.
- \*2 Operation not guaranteed when used with certain types of oils.

## Display Specifications

Display	TFT Color LCD	
Color/Shade	65,536 colors	
Effective Display Area	115.2W × 86.4H mm	
Display Resolution	640W × 480H pixels	
View Angle	Right and left 80°, up 80°, down 80°	
Backlight	LED	
Backlight Life	50,000 hours *1	
Brightness	800 cd/m <sup>2</sup> *2	
Brightness Adjustment	48 levels	
Backlight Replacement	Not possible	
Display Character Size	1/4 size	8 × 8 pixels (Western European language: ISO 8859-1, Central European language: ANSI 1250, Japanese katakana and symbols: JIS 8-bit code)
	1/2 size	8 × 16 pixels (Western European language ISO 8859-1, Central European language: ANSI 1250, Japanese katakana and symbols: JIS 8-bit code)
	Full size	16 × 32 pixels, 24 × 48 pixels, 32 × 64 pixels (Western European language: ISO 8859-1)
	Double size	16 × 16 pixels (Japanese JIS first and second level characters, simplified Chinese, traditional Chinese, Korean)
	Double size	32 × 32 pixels (Japanese JIS first level characters, Mincho font)
	Scalable	Width 8 to 128 dots (1/2 size fixed) (ISO 8859-1 western language, 7-segment)
Quantity of Characters	1/4 size	80 characters × 60 lines
	1/2 size	80 characters × 30 lines
	Full size	40 characters × 30 lines
	Double size	20 characters × 15 lines (Mincho font)
Character Magnification	0.5, 1 to 8 vertically and horizontally (except for scalable fonts)	
Character Attribute	Blink (1 or 0.5 sec period), reverse, bold, shadowed	
Graphics	Straight line, polyline, rectangle, circle, ellipse, arc, pie, equilateral polygons (3, 4, 5, 6, 8), paint, bitmap image	
Window Display	3 popup screens + 1 system screen	

- \*1 The backlight life is not guaranteed and refers to the time until the brightness reduces by half after use at 25°C. The actual life depends on operating environments and conditions.
- \*2 Brightness of the LCD only.

## Operation Specifications

Switching Element	Analog resistive membrane
Operating Force	3N maximum
Mechanical Life	1,000,000 operations
Acknowledgement Sound	Electronic buzzer

## Function Specifications

Screen Types	Base screen, popup screen, system screen
No. of Screens	Base screen: 3,000 max. Popup screen: 3,015 max.
User Memory	12 MB (including expansion fonts)
Parts	Bit Button, Word Button, Goto Screen, Print Button, Key Button, Multi Button, Keypad, Selector Switch, Potentiometer, Numerical Input, Character Input, Pilot Lamp, Multi-State Lamp, Picture Display, Message Display, Message Switching Display, Alarm List Display, Alarm Log Display, Numerical Display, Bar Graph, Trend Chart, Pie Chart, Meter, Calendar, Bit Write Command, Word Write Command, Goto Screen Command, Print Command, Timer, Screen Script Command, Multi Command
Calendar	Year, Month, Day, Hour, Min., Sec., Day of Week ±60 sec per month (at 25°C)
Power Failure Backup Data	Calendar, log data, keep internal relay, keep internal register
Battery	Recommended replacement span: every 5 years (at 25°C)

## Interface Specifications

Serial Interface (COM1)	Electrical Characteristics	EIA RS232C, RS422/485 compliant
	Transmission Speed	1200, 2400, 4800, 9600, 19200, 38400, 57600, 115200, 187500 bps (Note)
	Synchronization	Asynchronous
	Communication Method	Half or full duplex
	Control System	Hardware control or none
Connector	D-sub 9-pin connector	
Serial Interface (COM2)	Electrical Characteristics	EIA RS232C, RS422/485 compliant
	Transmission Speed	1200, 2400, 4800, 9600, 19200, 38400, 57600, 115200, 187500 bps (Note)
	Synchronization	Asynchronous
	Communication Method	Half or full duplex
	Control System	Hardware control or none
Connector	Detachable 9-pin terminal block	
Ethernet Interface (LAN)	Interface	IEEE802.3u (10/100BASE-T) compliant
	Connector	Modular connector (RJ-45)
USB Interface (USB2)	Interface	USB 2.0 high speed (480 Mbps)
	Connector	USB Type A connector
USB Interface (USB1)	Interface	USB 2.0 high speed (480 Mbps)
	Connector	USB Type Mini-B connector
Memory Card Interface (SD)	Interface	SD memory card, SDHC memory card
	Connector	SD memory card socket
Expansion Module Interface (EXT)	Interface	MicroSmart I/O module interface
	Output current	5V 130 mA 24V 150 mA
	Max. no. of units	2 units

Note: 187,500 bps is available only with SIEMENS SIMATIC S7-300/400 series (MPI port direct connection).

5.7  
inch

# HG2G Operator Interface (Basic)

Enhanced visibility and user-friendliness  
Supports a wide range of operating temperatures achieving high environmental resistance.

## HG2G-5TT (Color) / HG2G-5TN (Monochrome)

- LED 100,000 Hours
- 32-level Brightness Adjustment
- Stroke Fonts
- QVGA 320x240
- Serial Interface
- Ethernet
- USB mini-B
- USB A
- USB Flash Drive
- User Memory 5MB
- Front Panel Maintenance
- Voltage 12/24V DC
- Operating Temperature -20 to +60°C
- Vertical OK

Bezel Color: Light Gray, Dark gray, Silver

## HG2G-5TT (Color)

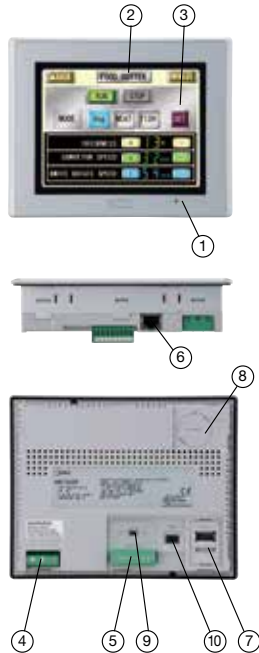

## HG2G-5TN (Monochrome)

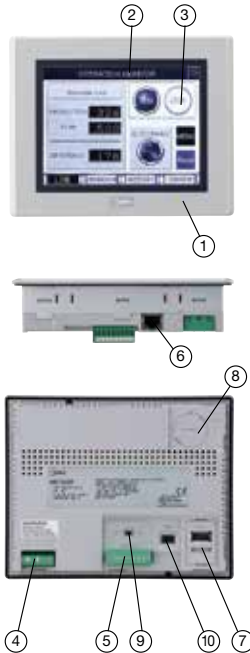

No.	Name
①	Power LED
②	Display
③	Touchscreen
④	Power Supply Terminal
⑤	Serial Interface 1 (COM1)
⑥	Ethernet Interface (LAN)
⑦	USB Interface (USB2)
⑧	Battery Cover
⑨	Terminal Resistor Switch
⑩	USB Interface (USB)

## HG2G-5TT (Color)

- Bright 500 cd/m<sup>2</sup>
- TFT 65,536 Colors
- Graphics

## HG2G-5TN (Monochrome)

- Bright 1100 cd/m<sup>2</sup>
- Monochrome 16 levels



(Approval for HG2G operator interface only, excluding options or expansion modules.)

## HG2G Operator Interface

Display Screen	Operation Style	Communication/Memory Interface	Housing/Bezel Color	Part No. (Ordering No.)	Approvals
5.7-inch TFT color LCD 65,536 colors	Touch Switch (analog resistive)	COM1 LAN USB 2	Light gray	HG2G-5TT22TF-W	UL508 CSA C22.2 No.142 CSA C22.2 No.213 ANSI/ISA-12.12.01
			Dark gray	HG2G-5TT22TF-B	
			Silver	HG2G-5TT22TF-S	
5.7-inch TFT Monochrome LCD 16 shades			Light gray	HG2G-5TN22TF-W	
			Dark gray	HG2G-5TN22TF-B	
			Silver	HG2G-5TN22TF-S	

• Models with a coated board that can be used even in harsh environments and bright color (1000 cd/m<sup>2</sup>) models are also available.

## Dimensions

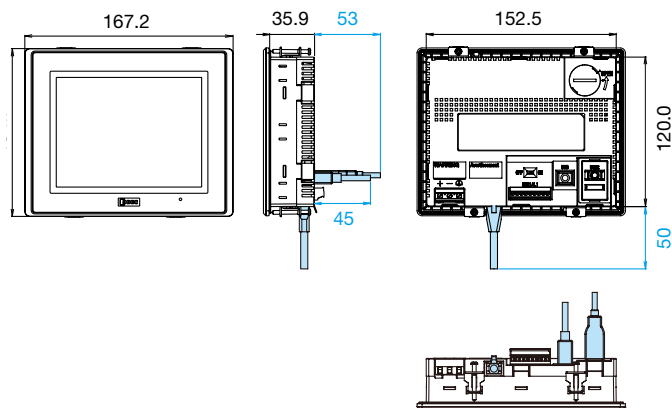

## Panel Cut-out

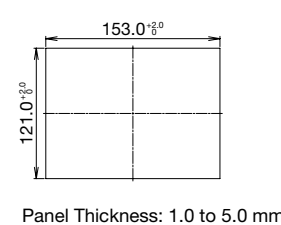

All dimensions in mm.

Note 1: Dimensions in blue show the mounting dimensions of the cable.

Note 2: Dimensions in the figure vary depending on the type of cable connected.

Note 3: Install the HG2G into a panel cut-out by tightening the four mounting clips (supplied) to a torque of 0.2 to 0.3 N-m.

Do not tighten with excessive force, otherwise the HG2G and screen may be distorted. Also waterproof characteristics may be lost.

## General Specifications

Model	HG2G-5TT (Color) / HG2G-5TN (Monochrome)
Rated Power Voltage	12V DC/24 V DC
Power Voltage Range	10.2 to 28.8V DC
Power Consumption	8W maximum 4W maximum when not using USB interface (USB2)
Allowable Momentary Power Interruption	10ms maximum (Voltage 20.4 to 28.8V DC) 1ms maximum (Voltage 10.2 to 20.4V DC)
Inrush Current	40A maximum
Dielectric Strength	1000V AC, 10 mA, 1 minute between power and FG terminals
Operating Temperature	-20 to +60°C
Operating Humidity	10 to 90% RH (no condensation)
Storage Temperature	-20 to +70°C
Storage Humidity	10 to 90% RH (no condensation)
Pollution Degree	2
Vibration Resistance	5 to 8.4 Hz amplitude 3.5 mm, 8.4 to 150 Hz, acceleration 9.8 m/s <sup>2</sup> 10 cycles (100 minutes) on each of three mutually perpendicular axes
Shock Resistance	147 m/s <sup>2</sup> , 11 ms 5 shocks on each of three mutually perpendicular axes
Noise Immunity	Fast transient/burst test, Power terminals: ±2 kV, Communication line: ±1 kV (IEC/EN 61131-2, IEC/EN 61000-4-4)
Electrostatic Discharge	Contact ±6 kV, air ±8 kV (IEC/EN 61131-2, IEC/EN 61000-4-2)
Corrosion Immunity	Free from corrosive gases
Mounting	Panel mounting (Panel Thickness: 1.0 to 5.0 mm)
Degree of Protection	IP66F (IEC 60529) (front part when mounted) *1 TYPE 4X TYPE 13 *2
Dimensions	167.2 W × 134.7 H × 40.9 D mm
Weight (approx.)	0.5 kg

- Do not use the HG2G in an environment subject to strong ultraviolet rays, otherwise the LCD quality will deteriorate.
- \*1 Protection degree of the front surface after mounting. Operation not guaranteed
- \*2 Operation not guaranteed when used with certain types of oils under certain environments.

## Display Specifications

Model	HG2G-5TT	HG2G-5TN
Display	TFT color LCD	TFT Monochrome LCD
Color/Shade	65,536	16 shades
Effective Display Area	115.2W × 86.4H mm	
Display Resolution	320W × 240H pixels	
View Angle	Right and left 80°, up 80°, down 80°	Right and left 65°, up 80°, down 60°
Backlight	LED	
Backlight Life	100,000 hours minimum *1	
Brightness	500 cd/m <sup>2</sup> *2	1100 cd/m <sup>2</sup> *2
Brightness Adjustment	32 levels	
Backlight Replacement	Not possible	
Display Character Size	1/4 size	8 × 8 pixels (Western European language: ISO 8859-1, Central European language: ANSI 1250, Baltic: ANSI 1257, Cyrillic: ANSI1251, Japanese katakana and symbols: JIS 8-bit code)
	1/2 size	8 × 16 pixels (Western European language: ISO 8859-1, Central European language: ANSI 1250, Baltic: ANSI 1257, Cyrillic: ANSI1251, Japanese katakana and symbols: JIS 8-bit code)
		16 × 32 pixels, 24 × 48 pixels, 32 × 64 pixels (Western European language: ISO 8859-1)
	Full size	16 × 16 pixels (Japanese JIS first and second level characters, simplified Chinese, traditional Chinese, Korean)
Quantity of Characters	Double size	32 × 32 pixels (Japanese JIS first level characters, Mincho font)
	1/4 size	40 characters × 30 lines
	1/2 size	40 characters × 15 lines
	Full size	20 characters × 15 lines
Character Magnification	0.5, 1 to 8 vertically and horizontally (except for scalable fonts)	
	Character Attribute: Blink (1 or 0.5 sec period), reverse, bold, shadowed	
Graphics	Straight line, polyline, rectangle, circle, ellipse, arc, pie, equilateral polygons (3, 4, 5, 6, 8), paint, bitmap image	
Window Display	3 popup screens + 1 system screen	

- \*1 The backlight life is not guaranteed and refers to the time until the brightness reduces by half after use at 25°C. The actual life depends on operating environments and conditions.
- \*2 Brightness of the LCD only.

## Operation Specifications

Switching Element	Analog resistive membrane
Operating Force	3N maximum
Mechanical Life	1,000,000 operations
Acknowledgement Sound	Electronic buzzer

## Function Specifications

Screen Types	Base screen, popup screen, system screen
No. of Screens	Base screen: 3,000 max. Popup screen: 3,015 max.
User Memory	5 MB (including expansion fonts)
Parts	Bit Button, Word Button, Goto Screen, Print Button Key Button, Multi Button, Keypad, Selector Switch, Potentiometer, Numerical Input, Character Input, Pilot Lamp, Multi-State Lamp, Picture Display, Message Display, Message Switching Display, Alarm List Display, Alarm Log Display, Numerical Display, Bar Graph, Trend Chart, Pie Chart, Meter, Calendar, Bit Write Command, Word Write Command, Goto Screen Command, Print Command Screen Script Command, Multi Command, Timer
Calendar	Year, Month, Day, Hour, Min., Sec., Day of Week ±60 sec per month (at 25 °C)
Power Failure Backup Data	Calendar, log data, keep internal relay, keep internal register
Battery	Recommended replacement span: every 5 years (at 25°C)

## Interface Specifications

Serial Interface 1 (COM1) *	RS232C	Electrical Characteristics	EIA RS232C compliant
		Transmission Speed	1200, 2400, 4800, 9600, 19200, 38400, 57600, 115200 bps
		Synchronization	Asynchronous
		Communication Method	Half or full duplex
		Control System	Hardware control or none
	EIA RS422/485	Electrical Characteristics	EIA RS422/485 compliant
		Transmission Speed	1200, 2400, 4800, 9600, 19200, 38400, 57600, 115200, 187500 bps (Note)
		Synchronization	Asynchronous
		Communication Method	Half or full duplex
		Control System	None
	Connector	Detachable 9-pin terminal block	
Ethernet Interface (LAN)	Interface	IEEE802.3u (10BASE-T/100BASE-TX) compliant	
	Connector	Connector (RJ-45)	
USB Interface (USB2)	Interface	USB 2.0 full speed (12 Mbps)	
	Connector	USB Type Mini-A connector	
USB Interface (USB1)	Interface	USB 2.0 high speed (480 Mbps)	
	Connector	USB Type Mini-B connector	

- \*RS232C and RS 422/485 can be used simultaneously.
- Note: 187,500 bps is available only with SIEMENS SIMATIC S7-300/400 series (MPI port direct connection).

# HG4G/3G/2G Operator Interface

## Options

Name	Part No. (Ordering No.)	Package Quantity	Description	Applicable Model				
				HG4G	HG3G	HG2G -5F	HG2G -5TT	HG2G -5TN
Application Software	SW1A-W1C	1	Automation Organizer (includes WindO/I-NV2,NV4)	√	√	√	√	√
USB Maintenance Cable (2m)	HG9Z-XCM42	1	USB Cable USB-miniB	√	√	√	√	√
PLC Connection Cable For IDEC MicroSmart (5m)	HG9Z-XC295	1	Mini DIN 8-pin (Dsub 9-pin)	√	√	√	—	—
PLC Connection Cable For Mitsubishi FX series (5m)	HG9Z-XC305	1	Mini DIN 8-pin (Dsub 9-pin)	√	√	√	—	—
PLC Connection Cable For Mitsubishi Q series (5m)	HG9Z-XC315	1	Mini DIN 6-pin (Dsub 9-pin)	√	√	√	—	—
PLC Connection Cable For IDEC MicroSmart (5m)	HG9Z-XC275	1	Mini DIN 8-pin (loose wire)	√	√	√	√	√
PLC Connection Cable For IDEC MicroSmart (2.4m)	FC2A-KP1C	1	Mini DIN 8-pin (loose wire)	√	√	√	√	√
USB panel-mount extension cable (1m)	HG9Z-XCE11	1	For USB-A port	√	√	√	—	—
	HG9Z-XCE21	1	For USB-mini B port	√	√	√	√	—
Connector Conversion Cable (16 cm)	HG9Z-XCT11	1	To convert from D-sub 25-pin to 9-pin (used when replacing from HG3F/4F to HG4G/3G/2G-F)	√	√	√	—	—
Memory Card	HG9Z-XMS2	1	SD Memory Card (2GB)	√	√	√	—	—
Protective Cover	HG9Z-2E2PN03	3	For 5.7 inch (3 pcs/pack) (used to cover the front side of the operator interface)	—	—	√	√	√
Protective Sheet *1	HG9Z-2D5PN05	5	For 5.7 inch (5 pcs/pack) (used to protect the LCD)	—	—	√	√	√
	HG9Z-3D8PN02	2	For 8.4-inch (2 pcs/pack)	—	√	—	—	—
	HG9Z-3DA2PN02	2	For 10.4-inch (2 pcs/pack)	—	√	—	—	—
	HG9Z-4DCPN02	2	For 12.1 inch (2 pcs/pack)	√	—	—	—	—
Expansion Module Clamp *2	HG9Z-XJ3PN05	5	For installing the expansion modules on the back of the operator interface (short). For total width 17.6 to 41.1 mm.	√	√	√	—	—
	HG9Z-XJ4PN05	5	For installing the expansion modules on the back of the operator interface (long). For total width 47.0 to 68.8 mm.	√	√	√	—	—
	HG9Z-XJ5PN05	5	For installing the expansion modules on the back of the operator interface (XL). For total width 70.5 to 92.3 mm.	√	√	√	—	—
L-shaped Terminal Block Connector for I/O Module *3	HG9Z-PMT10LPN02	2	For MicroSmart I/O Module (10-pole) (2 pcs/pack)	√	√	√	—	—
	HG9Z-PMT11LPN02	2	For MicroSmart I/O Module (11-pole) (2 pcs/pack)	√	√	√	—	—
Panel Mount Adaptor	HG9Z-2A1	1	Adaptor for mounting HG2G to the panel cut- out of HG2F.	—	—	√	√	√
	HG9Z-2A2	1	Adaptor for mounting HG2G to 156 x 123.5 mm panel cut-out.	—	—	√	√	√
User's Manual	HG9Y-B1119	1	English	√	√	√	—	—
	HG9Y-B1701			—	—	—	√	√

\*1 The protective sheet is UV resistant, however, resistance against direct sunlight in outdoor usage is not guaranteed.  
Used to protect the display screen.

\*2 Use the expansion module clamp when using expansion modules.  
Order the module clamp by referring to the width of the module shown in the dimensions of each module.

\*3 See Cat No. P1373 or instruction manual (<http://www.idec.com/language/>) for details on MicroSmart expansion modules.

## Maintenance Parts

Name	Part No. (Ordering No.)	Package Quantity	Description	Applicable Model				
				HG4G	HG3G	HG2G -5F	HG2G -5TT	HG2G -5TN
Mounting Clip	SLD-K02PN10	10	Four clips are supplied.	—	—	√	√	√
	HG9Z-4K2PN04	4	Four clips are supplied.	√	√	—	—	—
Serial Interface Connector (Detachable 9-pin terminal block)	HG9Z-XT09V	1	One plug (terminal block type) is supplied.	—	—	√	√	√
	HG9Z-XT09	1	One plug (terminal block type) is supplied.	√	√	—	—	—
Replacement Battery	HG9Z-XR1	1	Lithium battery CR2032 (one battery is supplied)	√	√	√	√	√
USB Cable Lock Pin	HG9Z-XU1PN05	5	Used to lock USB cable (for USB2).	√	√	√	√	√

## MICROSmart Expansion Modules

### Input Modules

Input	Part No. (Ordering No.)	Connector	Dimensions (L × W × H mm)	Consumption Current (mA)	
				5V	24V
8 points/AC Input	FC4A-N08A11	Removable Terminal Block	90.0 × 23.5 × 70.0	25	0
8 points/DC Input	FC4A-N08B1		90.0 × 23.5 × 70.0	25	0
16 points/DC Input	FC4A-N16B1		90.0 × 23.5 × 70.0	40	0
16 points/DC Input	FC4A-N16B3	MIL Connector	90.0 × 17.6 × 70.0	35	0
32 points/DC Input	FC4A-N32B3		90.0 × 29.7 × 70.0	65	0

### Output Modules

Output	Part No. (Ordering No.)	Connector	Dimensions (L × W × H mm)	Consumption Current (mA)	
				5V	24V
8 points/Relay Output	FC4A-R081	Removable Terminal Block	90.0 × 23.5 × 70.0	30	40
16 points/Relay Output	FC4A-R161		90.0 × 23.5 × 70.0	45	75
8 points/Transistor Sink Output	FC4A-T08K1		90.0 × 23.5 × 70.0	10	20
8 points/Transistor Source Output	FC4A-T08S1		90.0 × 23.5 × 70.0	10	20
16 points/Transistor Sink Output	FC4A-T16K3	MIL Connector	90.0 × 17.6 × 70.0	10	40
16 points/Transistor Source Output	FC4A-T16S3		90.0 × 17.6 × 70.0	10	40
32 points/Transistor Sink Output	FC4A-T32K3		90.0 × 29.7 × 70.0	20	70
32 points/Transistor Source Output	FC4A-T32S3		90.0 × 29.7 × 70.0	20	70

### Combination I/O Modules

Input/Output	Part No. (Ordering No.)	Connector	Dimensions (L × W × H mm)	Consumption Current (mA)	
				5V	24V
4 points/DC Input 4 points/Relay Output	FC4A-M08BR1	Removable Terminal Block	90.0 × 23.5 × 70.0	25	20
16 points/DC Input 8 points/Relay Output	FC4A-M24BR2	Non-removable Terminal Block	90.0 × 39.1 × 70.0	65	45

- IDEC PLC MicroSmart expansion I/O modules can be used.  
<Maximum number of expansion I/O modules>
  - HG4G/3G: Up to 4 modules (Note)
  - HG2G-5F: Up to 2 modules
- Only one FC4A-M24BR2 module can connect to one main unit.
- Use the expansion module clamp when using expansion modules.  
Order the module clamp by referring to the width of the module shown in the dimensions of each module.  
Note: When connecting more than 3 expansion modules to the HG4G/3G, note the limits shown below:  
<Limits>  
Current flow rate at 5V: 130 mA max.      Total width: 92.3 mm max.  
Current flow rate at 24V: 150 mA max.
- See catalog or instruction manual (<http://www.idec.com/language/>) for details on MicroSmart expansion modules.

# HG4G/3G/2G Operator Interface

## Compatible PLCs

Manufacturer	Series
IDEC	MICROSmart
	SmartAXIS Pro/Lite
	MICROSmart (Ethernet)
	SmartAXIS Pro/Lite (Ethernet)
Mitsubishi	MELSEC-A (link unit)
	MELSEC-QnA (link unit)
	MELSEC-Q (link unit)
	MELSEC-Q (Ethernet)
	MELSEC-FX
OMRON	SYSMAC-C
	SYSMAC-CS
	SYSMAC-CJ1
	SYSMAC-CJ2
	SYSMAC-CP1
	SYSMAC (Ethernet)
Allen-Bradley (Note)	PLC-5 (Half Duplex)
	SLC-500 (Half Duplex)
	MicroLogix (Full Duplex)
	ControlLogix (Full Duplex)
	CompactLogix (Full Duplex)
	FlexLogix (Full Duplex)
	ControlLogix (Ethernet/IP, Ethernet/IP (Logix Native Tag))
	CompactLogix (Ethernet/IP, Ethernet/IP (Logix Native Tag))
	PLC-5 (Ethernet/IP)
	SLC 500 (Ethernet/IP)
MicroLogix (Ethernet/IP)	
SIEMENS	S7-200
	S7-300 (connects to CPU)
	S7-300 (link unit)
	S7-400
	S7-1200 (Ethernet)
Keyence	KV-700/1000/3000/5000
	KV Nano
	KZ
	KV (Ethernet)
Hitachi	S10mini
	S10V
JTEKT	TOYOPUC-PC2J
	TOYOPUC-PC3J
Toshiba Machine Works	TC200
	TCmini
GE Fanuc Automation	Series90-30
	VersaMax

Manufacturer	Series
Schneider	Twido
Modicon	Modbus RTU Master (*1)
	Modbus RTU Slave (*2)
	Modbus ASCII Master (*1)
	Modbus TCP Client (*1)
Panasonic	FP Series
	MP
Yaskawa Electric	MP (Ethernet)
	DirectLOGIC 05
Koyo	DirectLOGIC 06
	DirectLOGIC 205
	KOSTAC SZ
	KOSTAC SU
	KOSTAC SU (Ethernet)
Fanuc	Power Mate
	Series
Yokogawa Electric	FA-M3
	FA-M3 (Ethernet)
Fuji Electric	FREX-PC
	MICREX-F
	MICREX-SX (Ethernet)
Toshiba	PROSEC T Series
	V Series
LS Industrial Systems	MASTER-K
VIGOR	VB
	VH
Emerson	FloBoss
Hitachi Industrial Equipment Systems	EH (Ethernet)

Note: HG2G-5TT and HG2G-5TN cannot communicate using Ethernet/IP (Logix Native Tag)

- The compatible PLC information is for reference only (except for IDEC PLCs), and IDEC does not guarantee the operation of any other manufacturers' PLC. When using other manufacturers' PLCs, read their specifications and instruction manual carefully. The PLC must be operated correctly under the user's responsibility.
- The company names and product names are registered trademarks or brand names.

\*1 HG4G/3G/2G is connected as a master.

\*2 HG4G/3G/2G is connected as a slave.

An updated listing of compatible PLCs can be found at the following website.  
<http://www.idec.com/oi/drivers>

# IDEC CORPORATION

 [www.idec.com](http://www.idec.com)

## Head Office

6-64, Nishi-Miyahara-2-Chome, Yodogawa-ku, Osaka 532-0004, Japan

<b>USA</b>	IDEC Corporation	Tel: +1-408-747-0550	opencontact@idec.com
<b>Germany</b>	IDEC Electrotechnik GmbH	Tel: +49-40-25 30 54 - 0	service@eu.idec.com
<b>Singapore</b>	IDEC Izumi Asia Pte. Ltd.	Tel: +65-6746-1155	info@sg.idec.com
<b>Thailand</b>	IDEC Asia (Thailand) Co., Ltd	Tel: +66-2-392-9765	sales@th.idec.com
<b>Australia</b>	IDEC Australia Pty. Ltd.	Tel: +61-3-8523-5900	sales@au.idec.com
<b>Taiwan</b>	IDEC Taiwan Corporation	Tel: +886-2-2698-3929	service@tw.idec.com

<b>Hong Kong</b>	IDEC Izumi (H.K.) Co., Ltd.	Tel: +852-2803-8989	info@hk.idec.com
<b>China/Shanghai</b>	IDEC (Shanghai) Corporation	Tel: +86-21-6135-1515	idec@cn.idec.com
<b>China/Shenzhen</b>	IDEC (Shenzhen) Corporation	Tel: +86-755-8356-2977	idec@cn.idec.com
<b>China/Beijing</b>	IDEC (Beijing) Corporation	Tel: +86-10-6581-6131	idec@cn.idec.com
<b>Japan</b>	IDEC Corporation	Tel: +81-6-6398-2527	marketing@idec.co.jp

Specifications and other descriptions in this brochure are subject to change without notice.  
 2017 IDEC Corporation, All Rights Reserved.

EP1521-3 APRIL 2017

